

Tafeln

Objektyp: **Chapter**

Zeitschrift: **Archäologie Graubünden. Sonderheft**

Band (Jahr): **5 (2016)**

Heft 2

PDF erstellt am: **16.07.2024**

Nutzungsbedingungen

Die ETH-Bibliothek ist Anbieterin der digitalisierten Zeitschriften. Sie besitzt keine Urheberrechte an den Inhalten der Zeitschriften. Die Rechte liegen in der Regel bei den Herausgebern.

Die auf der Plattform e-periodica veröffentlichten Dokumente stehen für nicht-kommerzielle Zwecke in Lehre und Forschung sowie für die private Nutzung frei zur Verfügung. Einzelne Dateien oder Ausdrucke aus diesem Angebot können zusammen mit diesen Nutzungsbedingungen und den korrekten Herkunftsbezeichnungen weitergegeben werden.

Das Veröffentlichen von Bildern in Print- und Online-Publikationen ist nur mit vorheriger Genehmigung der Rechteinhaber erlaubt. Die systematische Speicherung von Teilen des elektronischen Angebots auf anderen Servern bedarf ebenfalls des schriftlichen Einverständnisses der Rechteinhaber.

Haftungsausschluss

Alle Angaben erfolgen ohne Gewähr für Vollständigkeit oder Richtigkeit. Es wird keine Haftung übernommen für Schäden durch die Verwendung von Informationen aus diesem Online-Angebot oder durch das Fehlen von Informationen. Dies gilt auch für Inhalte Dritter, die über dieses Angebot zugänglich sind.



Tafeln

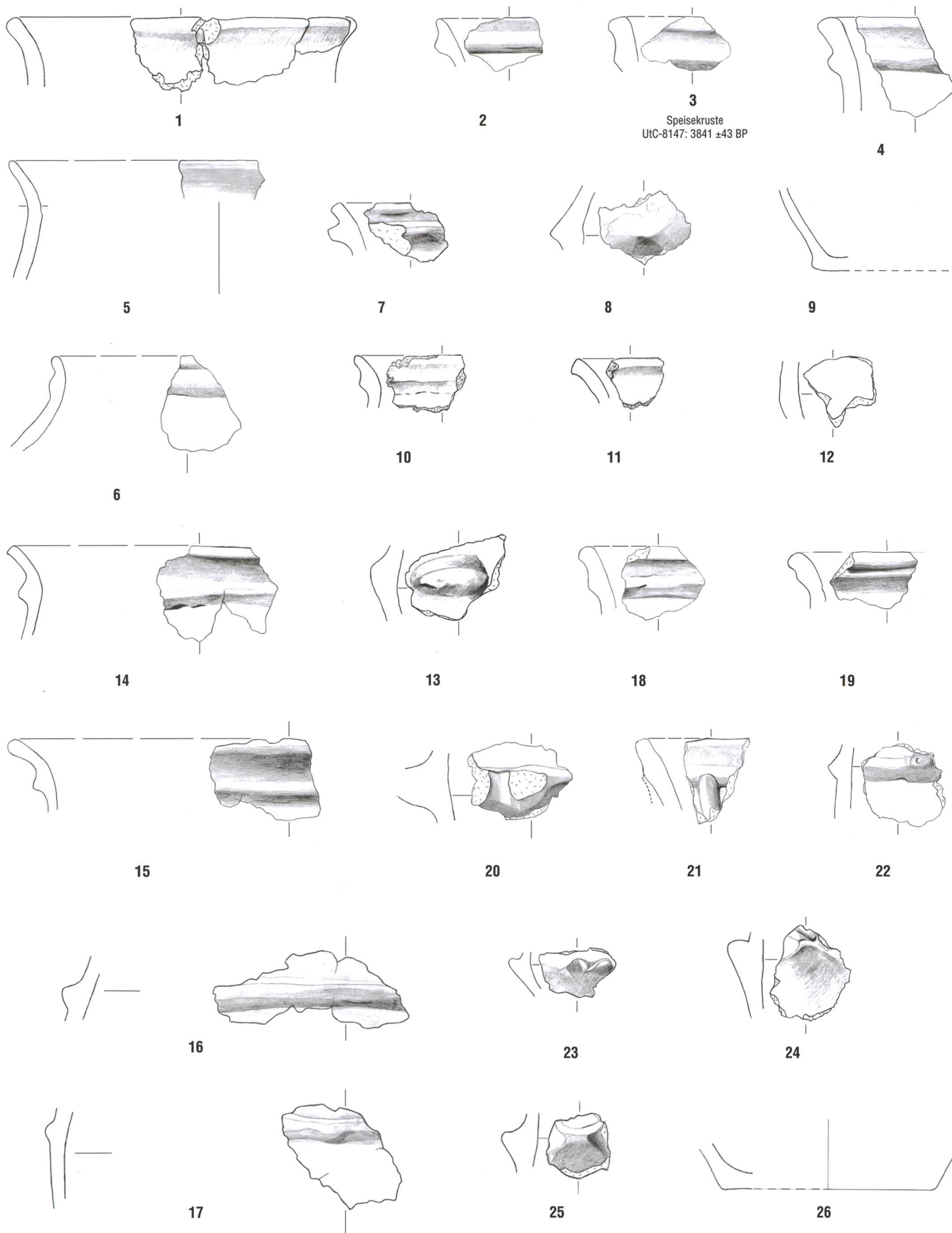

Tafel 1: Cazis, Cresta 1947–1970. Nördliche Zentralspalte, Keramikhorizont KH I. 1–9: Planum 1N. 10–13: zwischen Planum 1aN und 3aN. 13–26: Planum 2N. Keramik. Mst. 1:3.

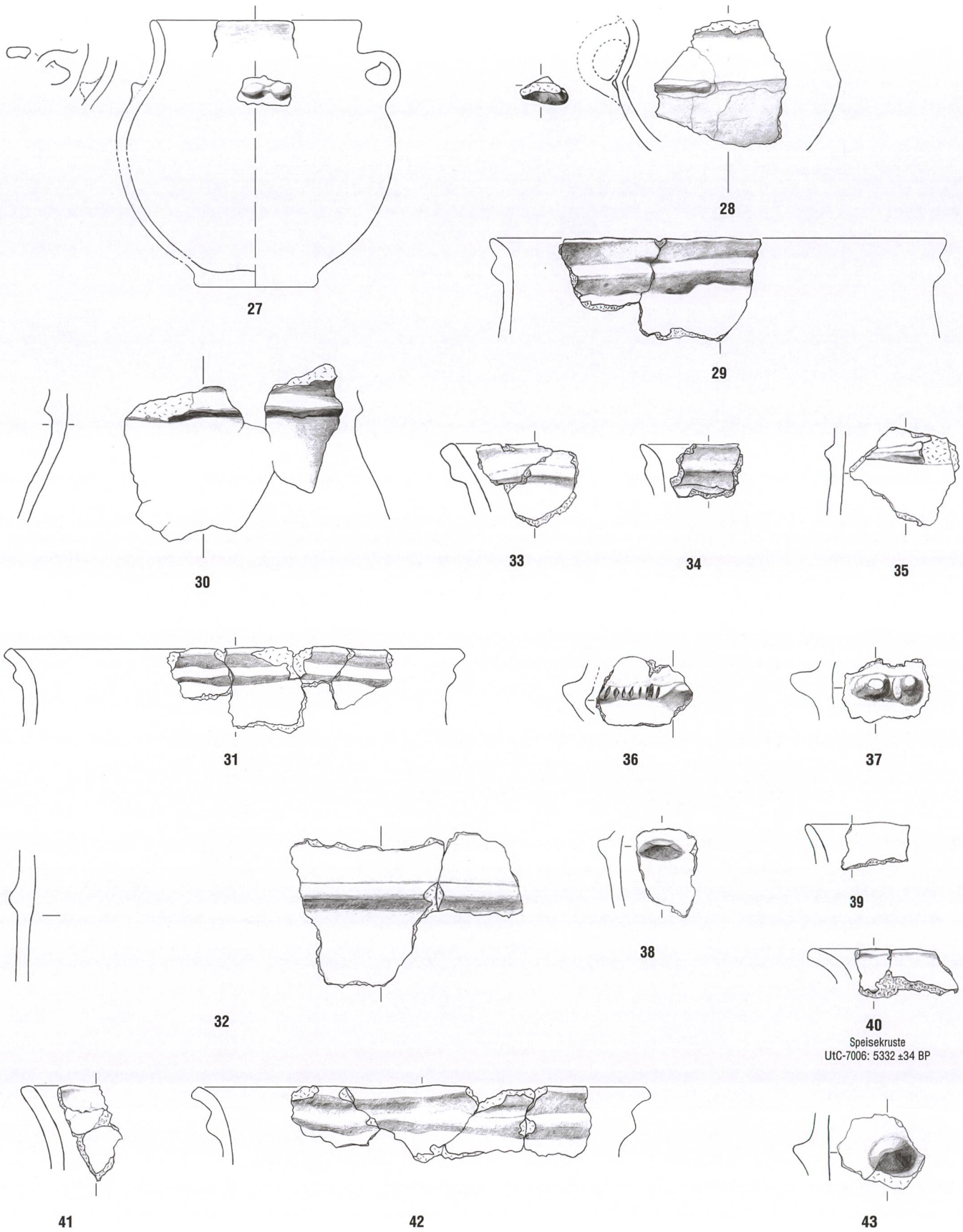

Tafel 2: Cazis, Cresta 1947-1970. Nördliche Zentralspalte, Keramikhorizont KH I. 27: Planum 2N. 28: Plana 1N-2N. 29-30, 32-41 Planum 3bN. 31, 42-43: Planum 3N. Keramik. Mst. 1:3.

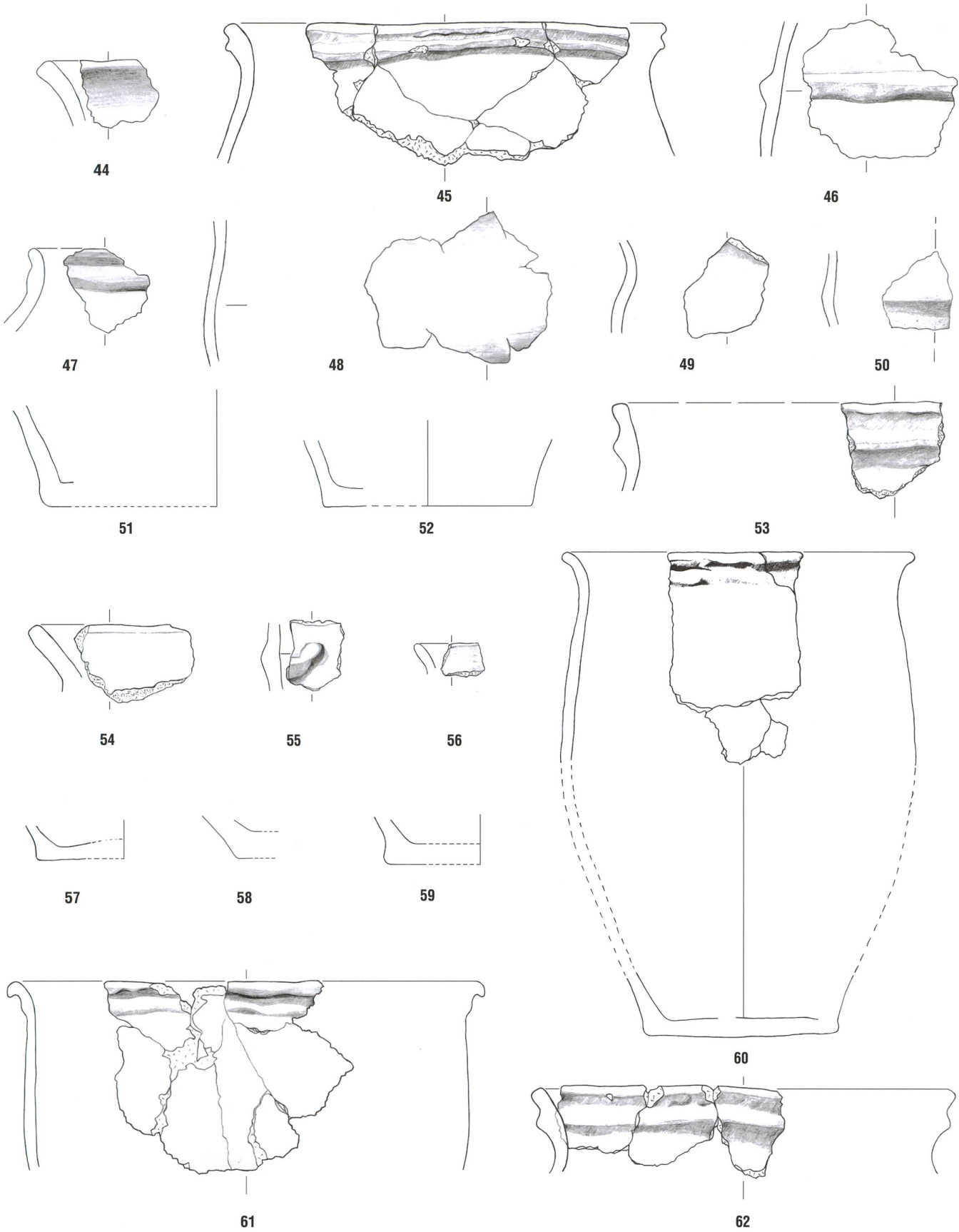

Tafel 3: Cazis, Cresta 1947–1970. Nördliche Zentralspalte, Keramikhorizont KH I. 44–52: Planum 3N. 53–59: Planum 3cN. 60–62: Planum 4N. Keramik. Mst. 1:3.

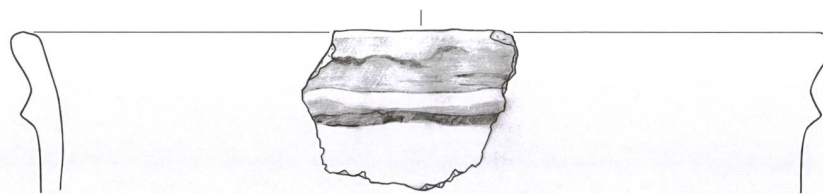

63

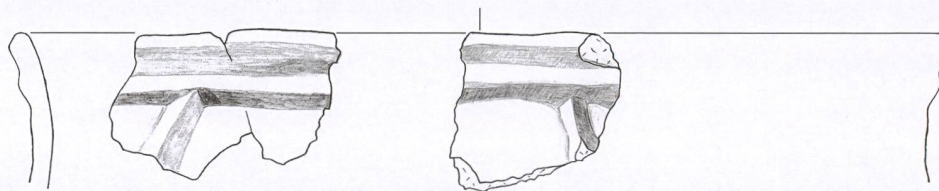

64

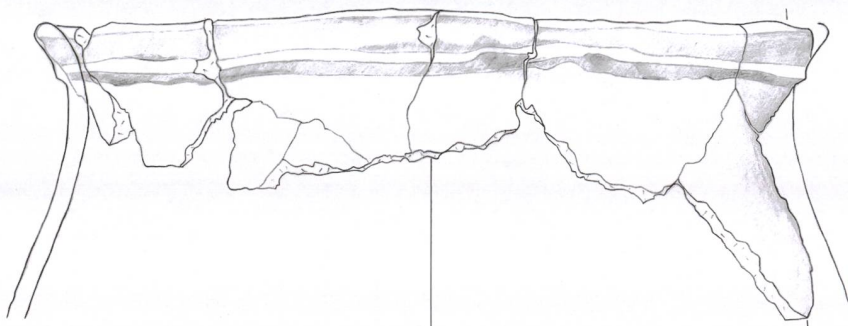

65



66

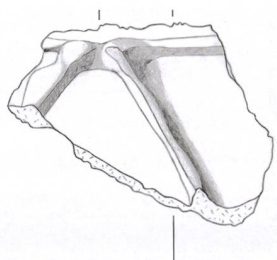

67

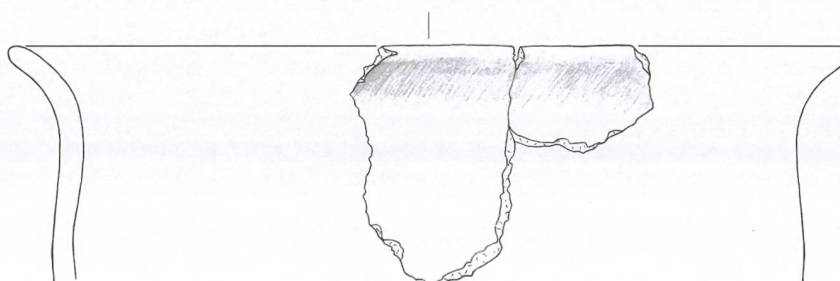
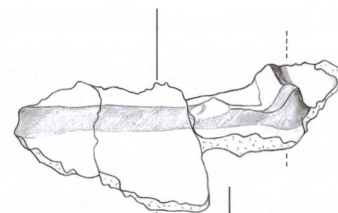

68

Tafel 4: Cazis, Cresta 1947-1970. Nördliche Zentralspalte, Keramikhorizont KH I. 63-68: Planum 4N. Keramik. Mst. 1:3.

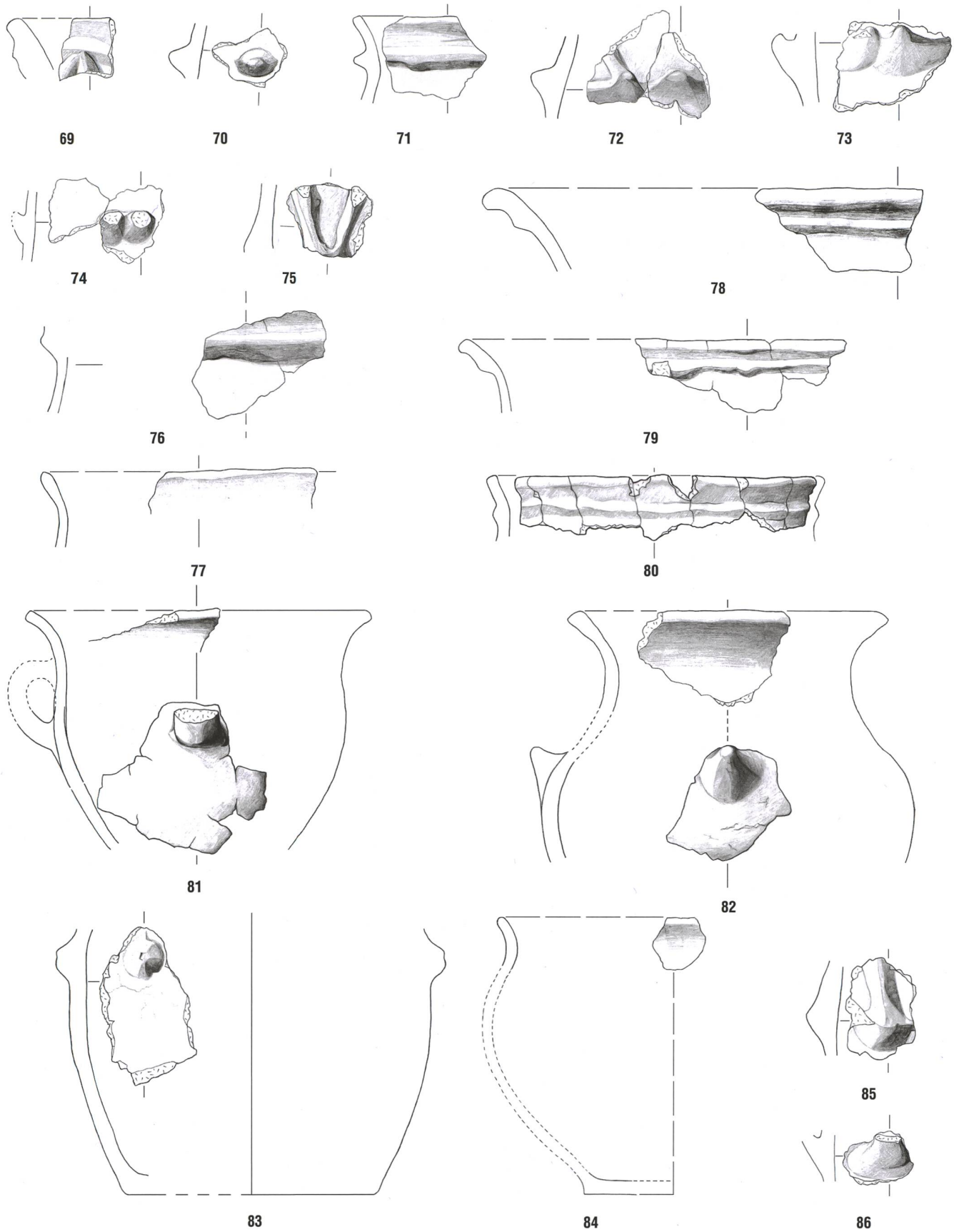

Tafel 5: Cazis, Cresta 1947–1970. Nördliche Zentralspalte, Keramikhorizont KH I. 69–86: Planum 4N. Keramik. Mst. 1:3.

87-96

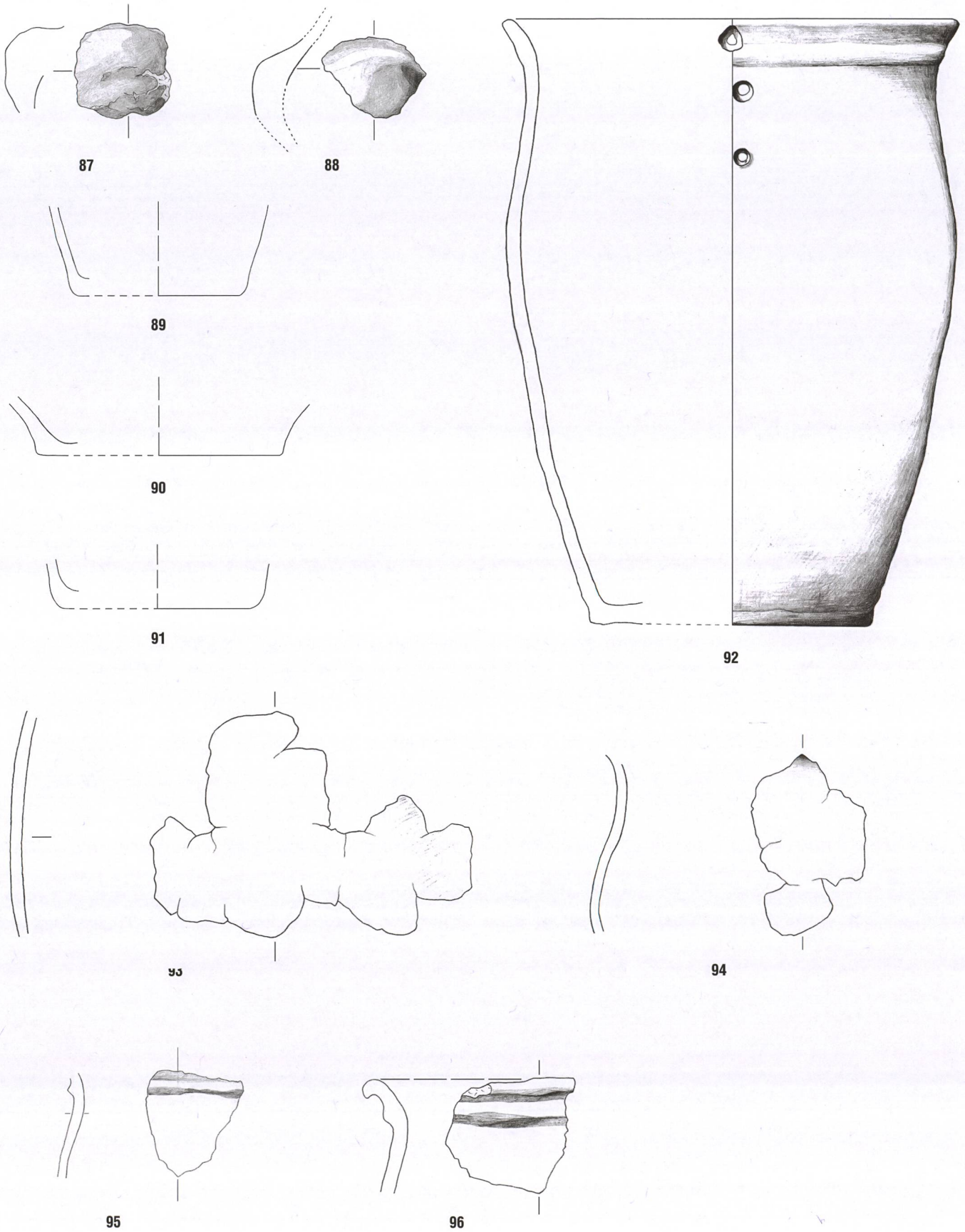

Tafel 6: Cazis, Cresta 1947-1970. Nördliche Zentralspalte, Keramikhorizont KH I. 87-92: Planum 4N. 93-96: Planum 4aN. Keramik. Mst. 1:3.

97-108

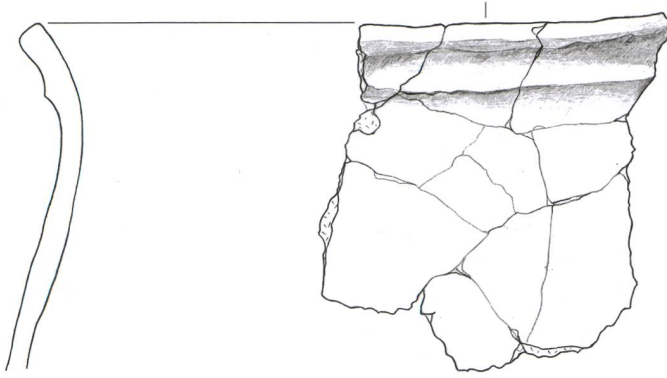

97

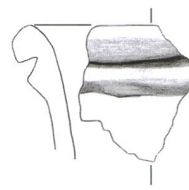

98

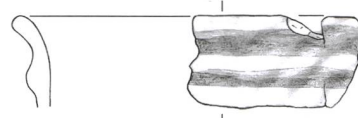

99

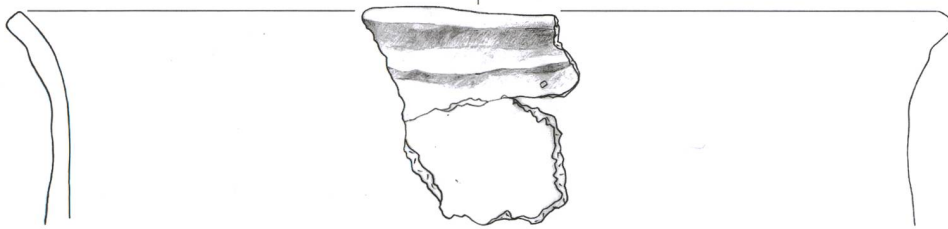

100

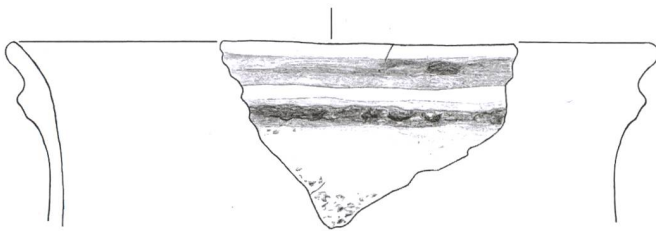

101

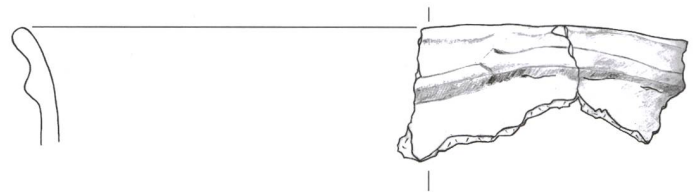

102

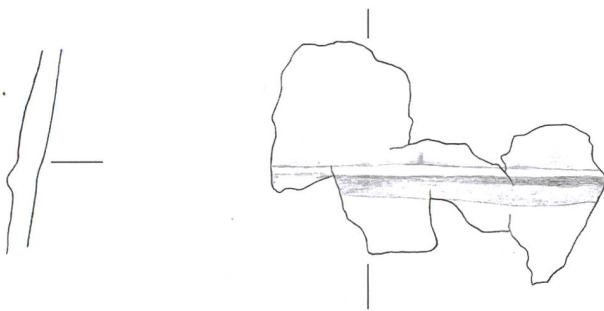

103

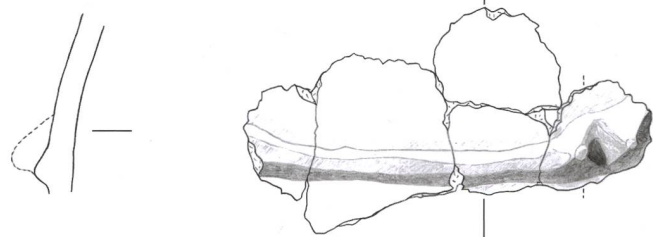

104

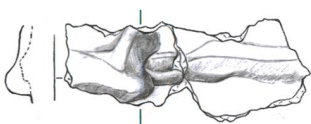

105

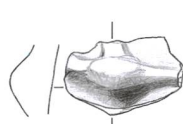

106

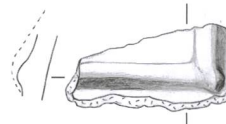

107



108

Tafel 7: Cazis, Cresta 1947-1970. Nördliche Zentralspalte, Keramikhorizont KH I. 97-108: Planum 4aN. Keramik. Mst. 1:3.

109-120

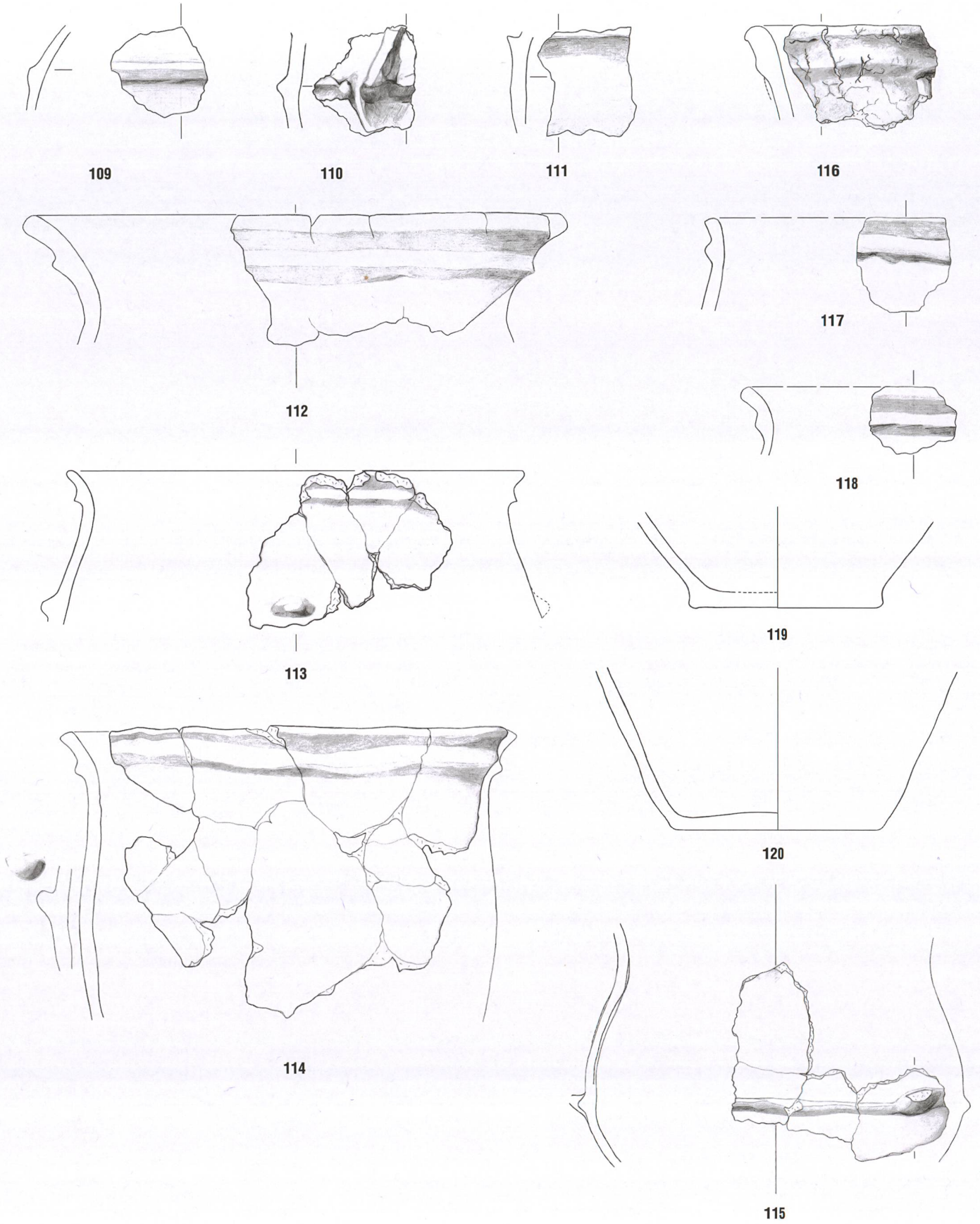

Tafel 8: Cazis, Cresta 1947-1970. Nördliche Zentralspalte, Keramikhorizont KH I. 109-115: Planum 4aN. Keramik. Mst. 1:3.

121-136

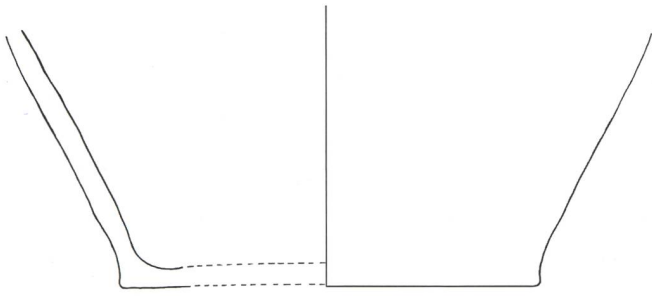

121

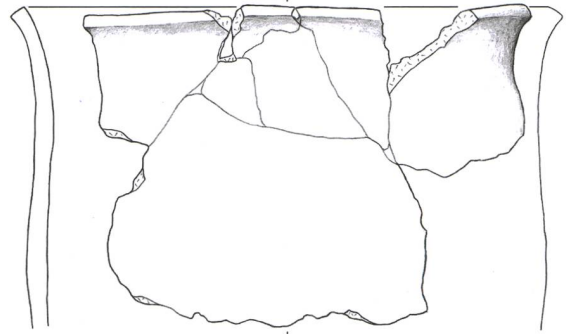

125

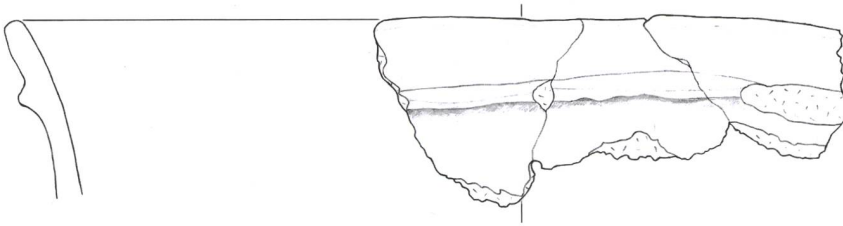

122

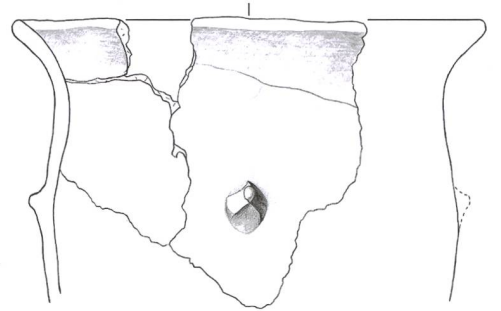

126

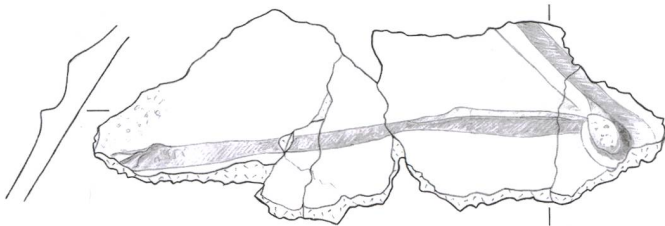

123

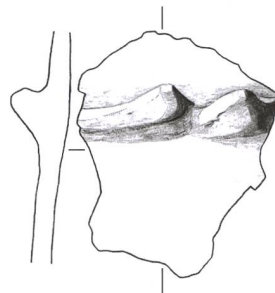

127

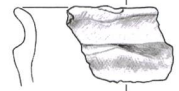

128

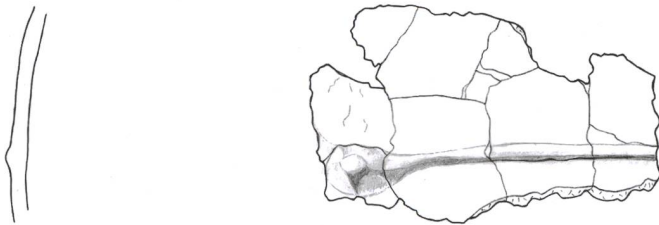

124

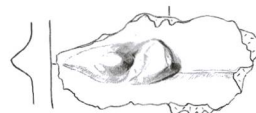

129

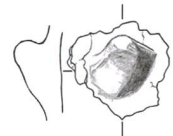

130

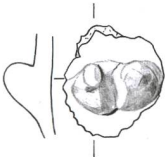

131

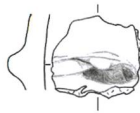

132



133

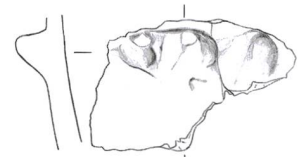

134

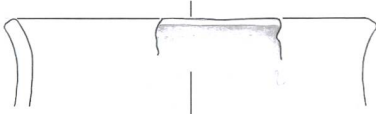

135

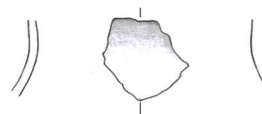

136

Tafel 9: Cazis, Cresta 1947-1970. Nördliche Zentralspalte, Keramikhorizont KH I. 116-136: Planum 4aN. Keramik. Mst. 1:3.

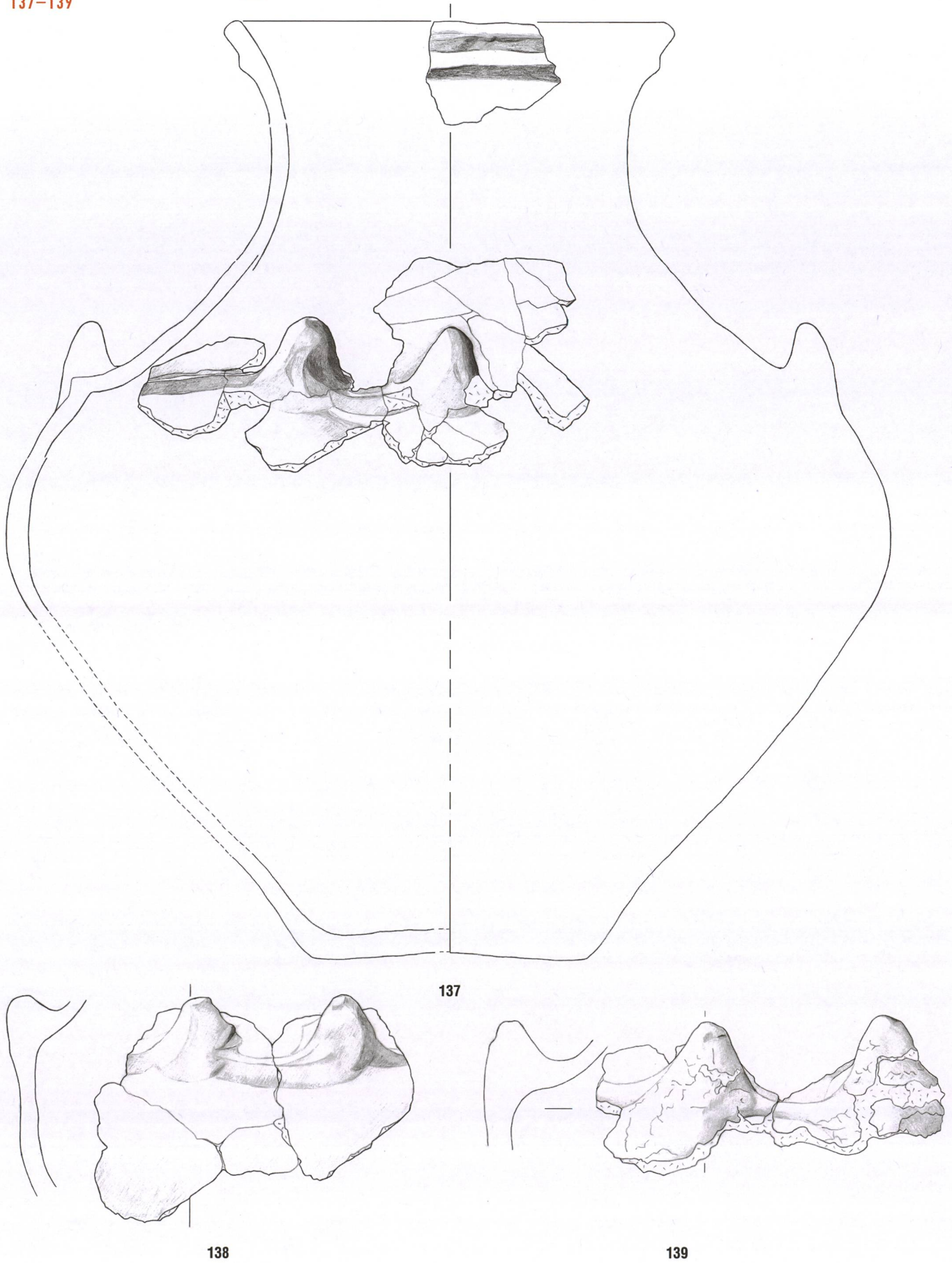

Tafel 10: Cazis, Cresta 1947-1970. Nördliche Zentralspalte, Keramikhorizont KH I. 137: Planum 4aN. Keramik. Mst. 1:3.

140-147

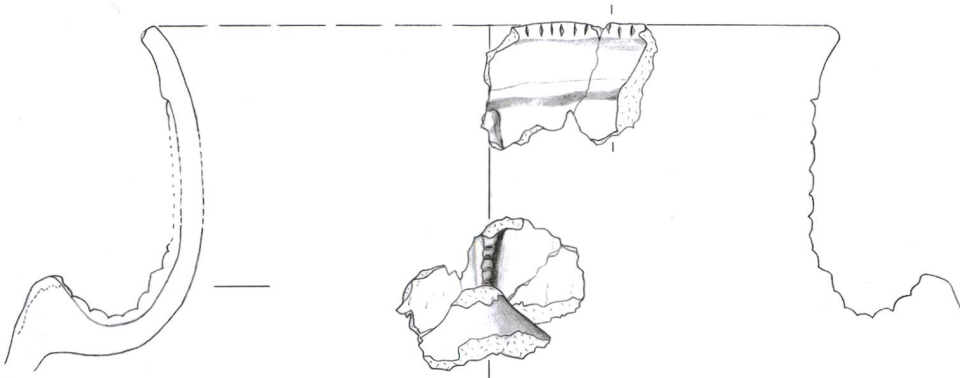

140

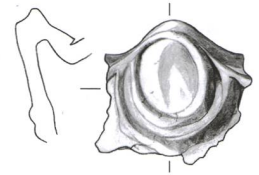

143

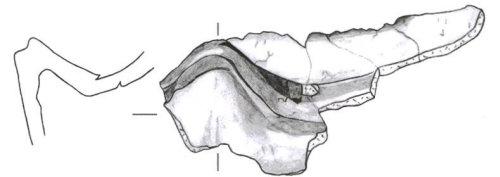

144

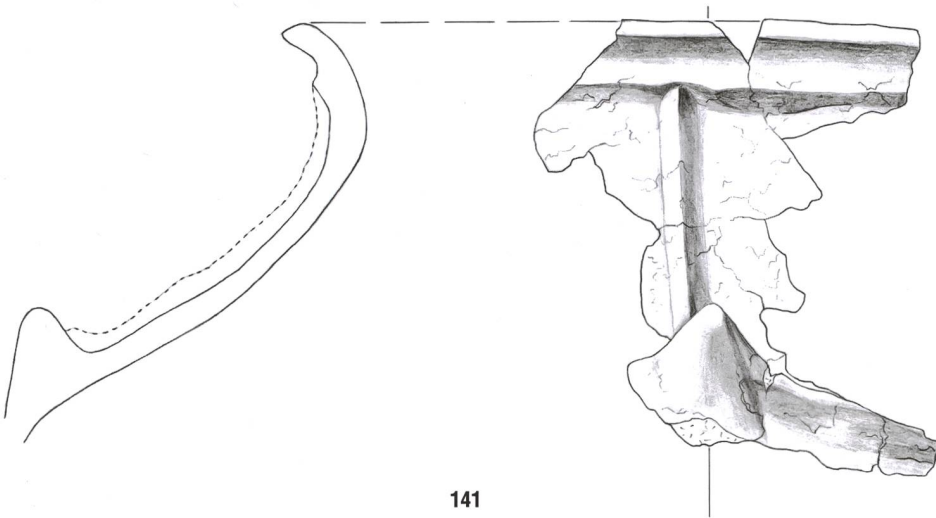

141

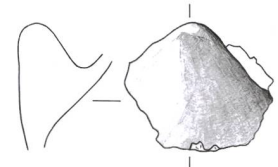

145

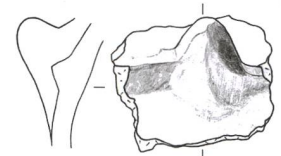

146

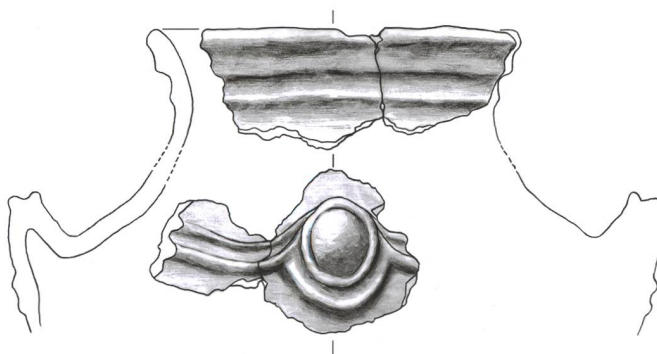

142

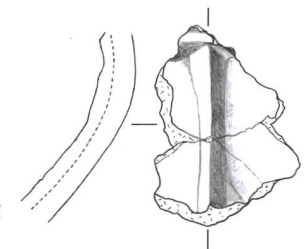

147

Tafel 11: Cazis, Cresta 1947-1970. Nördliche Zentralspalte, Keramikhorizont KH I. 138-147: Planum 4aN. Keramik. Mst. 1:3.

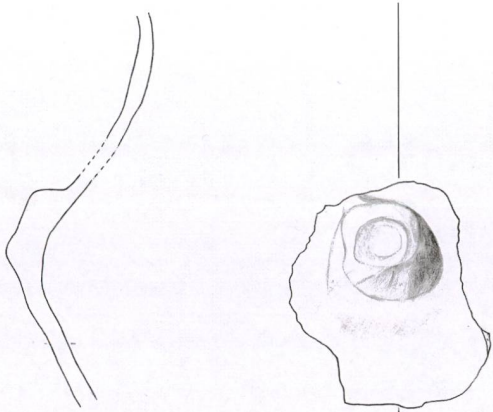

148

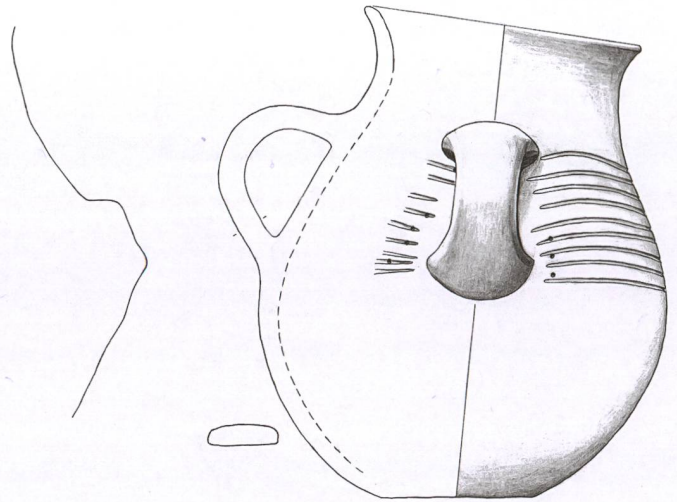

149

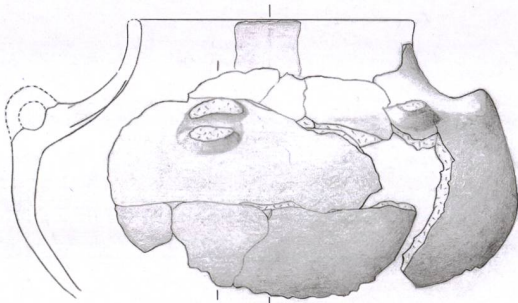

150

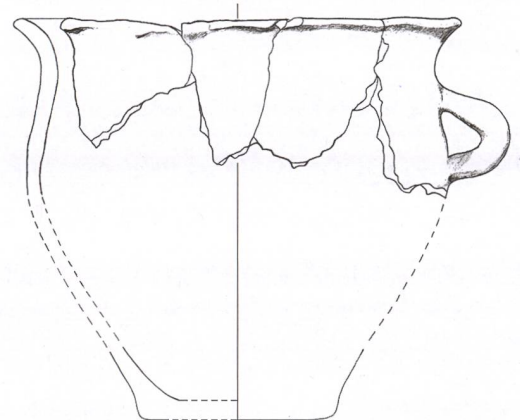

151

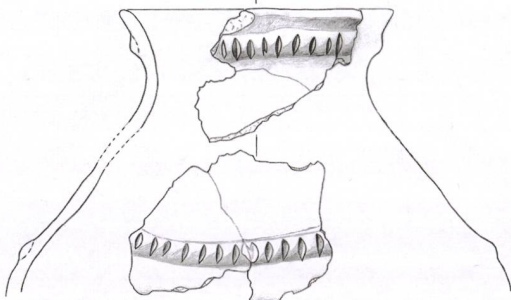

152

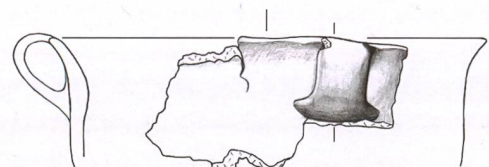

153

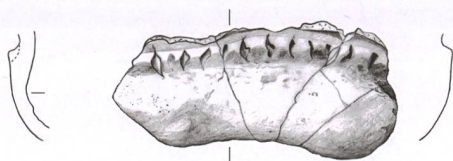

154

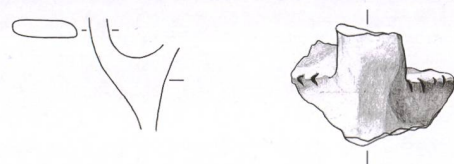

155

Tafel 12: Cazis, Cresta 1947-1970. Nördliche Zentralspalte, Keramikhorizont KH I. 148-155: Planum 4aN. Keramik. Mst. 1:3.

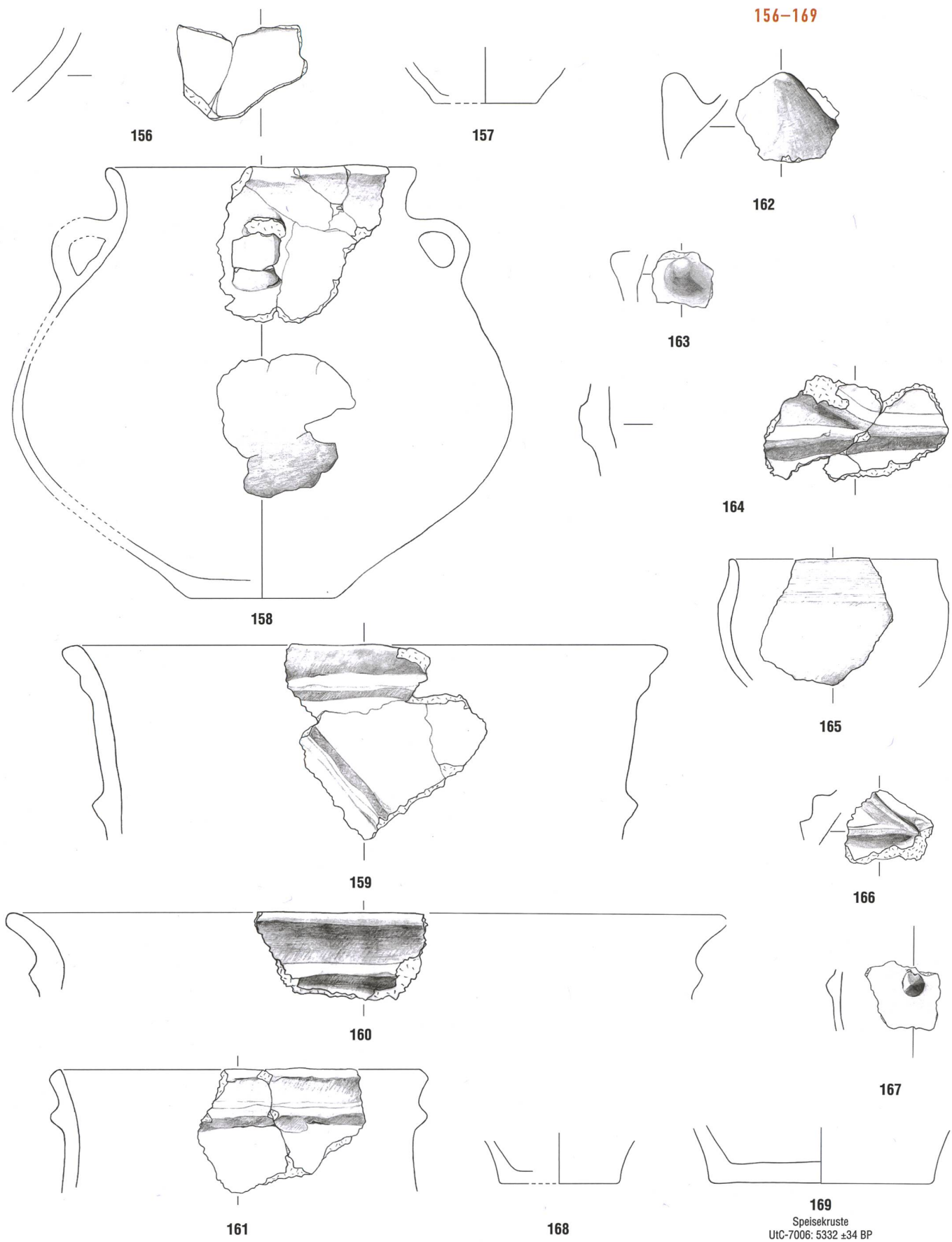

Tafel 13: Cazis, Cresta 1947–1970. Nördliche Zentralspalte, Keramikhorizont KH I. 156–157: Planum 4aN. 158: Plana 4N – 5N. 159, 162–163: Planum 5N. 160–161, 164–169: Planum 5bN. Keramik. Mst. 1:3.

170-176

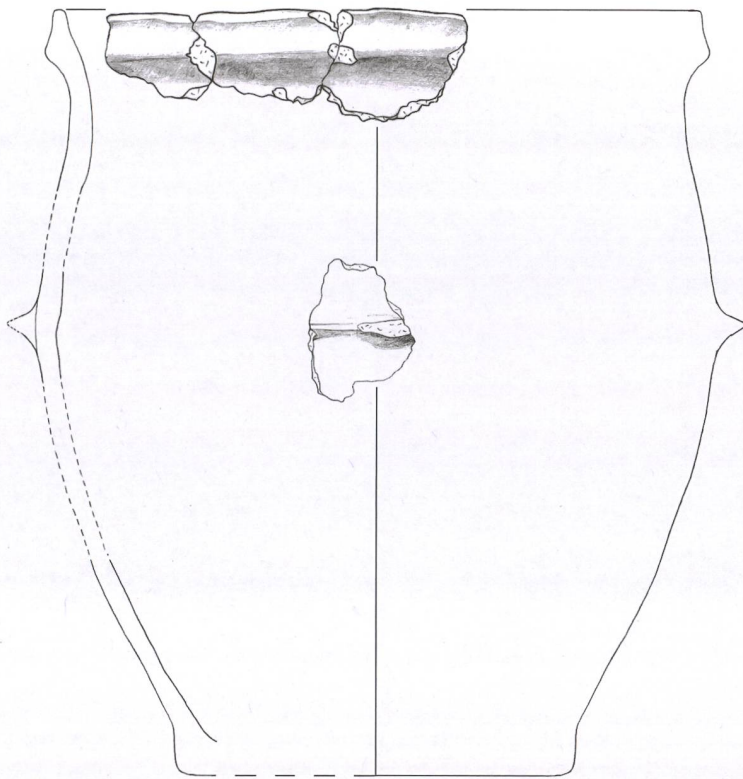

170



171

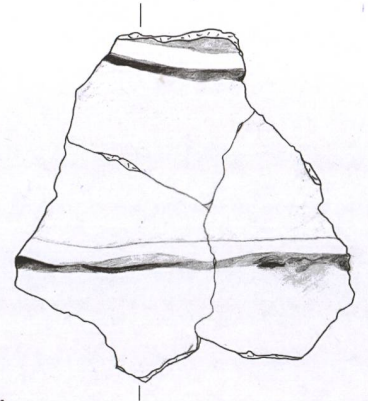

173

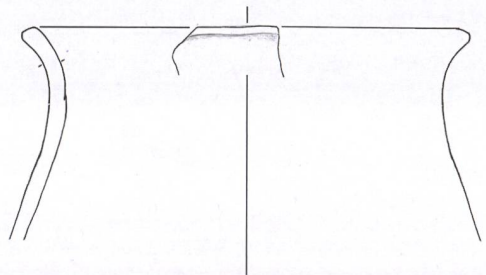

172

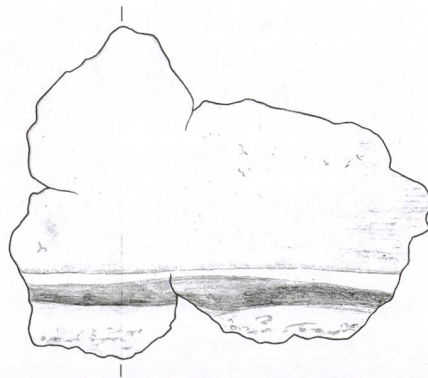

175

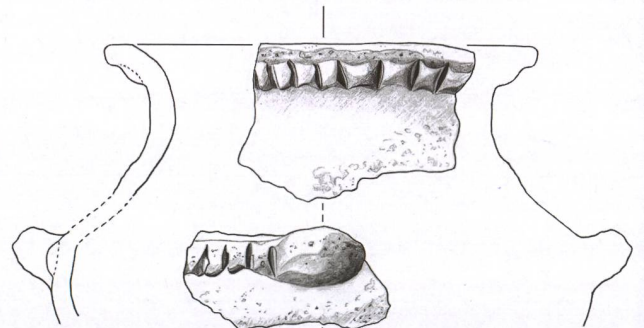

174



176

Tafel 14: Cazis, Cresta 1947-1970. Nördliche Zentralspalte, Keramikhorizont KH II. 170-176: Planum 6N. Keramik. Mst. 1:3.

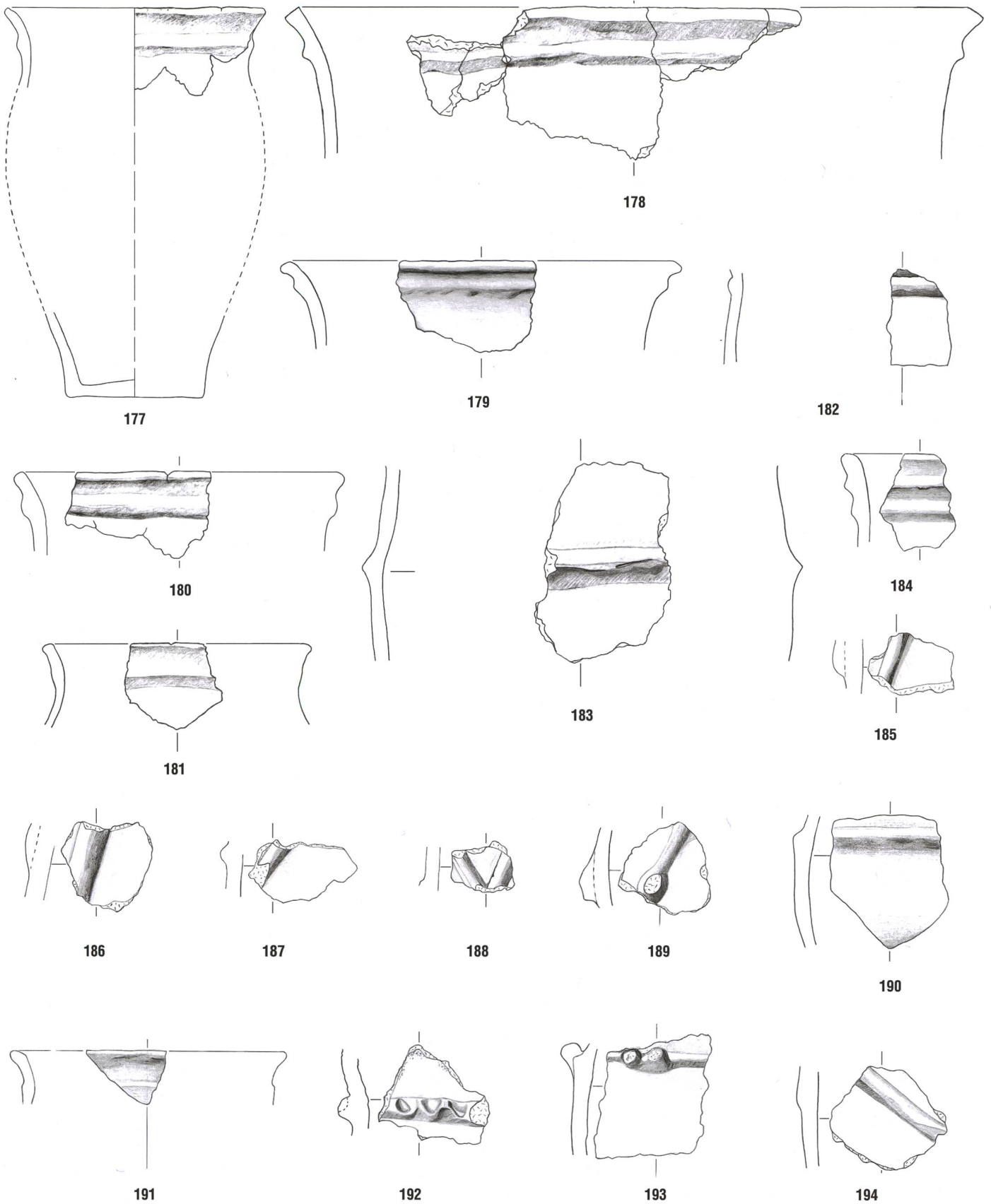

Tafel 15: Cazis, Cresta 1947-1970. Nördliche Zentralspalte, Keramikhorizont KH II. 177-194: Planum 6N. Keramik. Mst. 1:3.

195-212

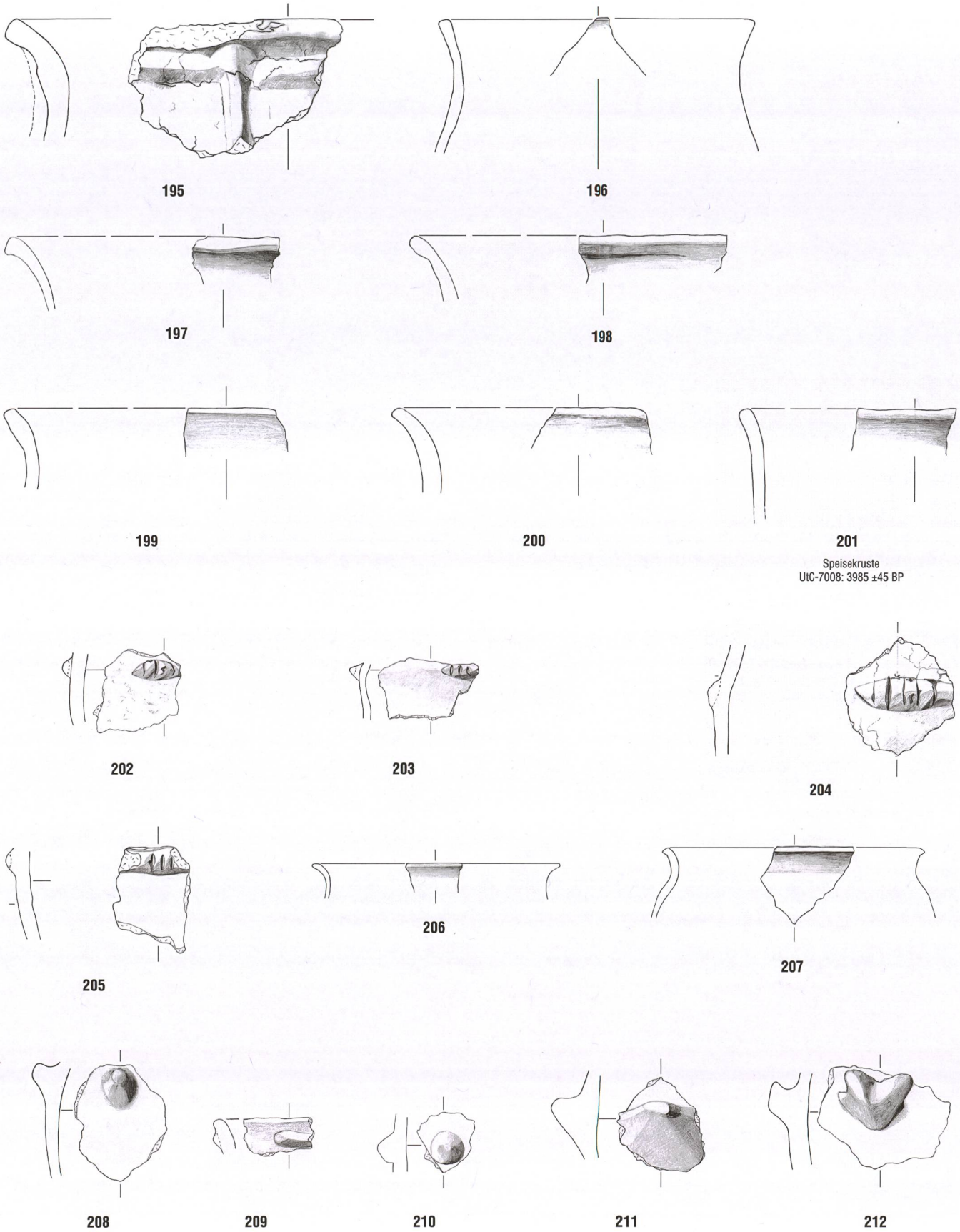

Tafel 16: Cazis, Cresta 1947-1970. Nördliche Zentralspalte, Keramikhorizont KH II. 195-212: Planum 6N. Keramik. Mst. 1:3.

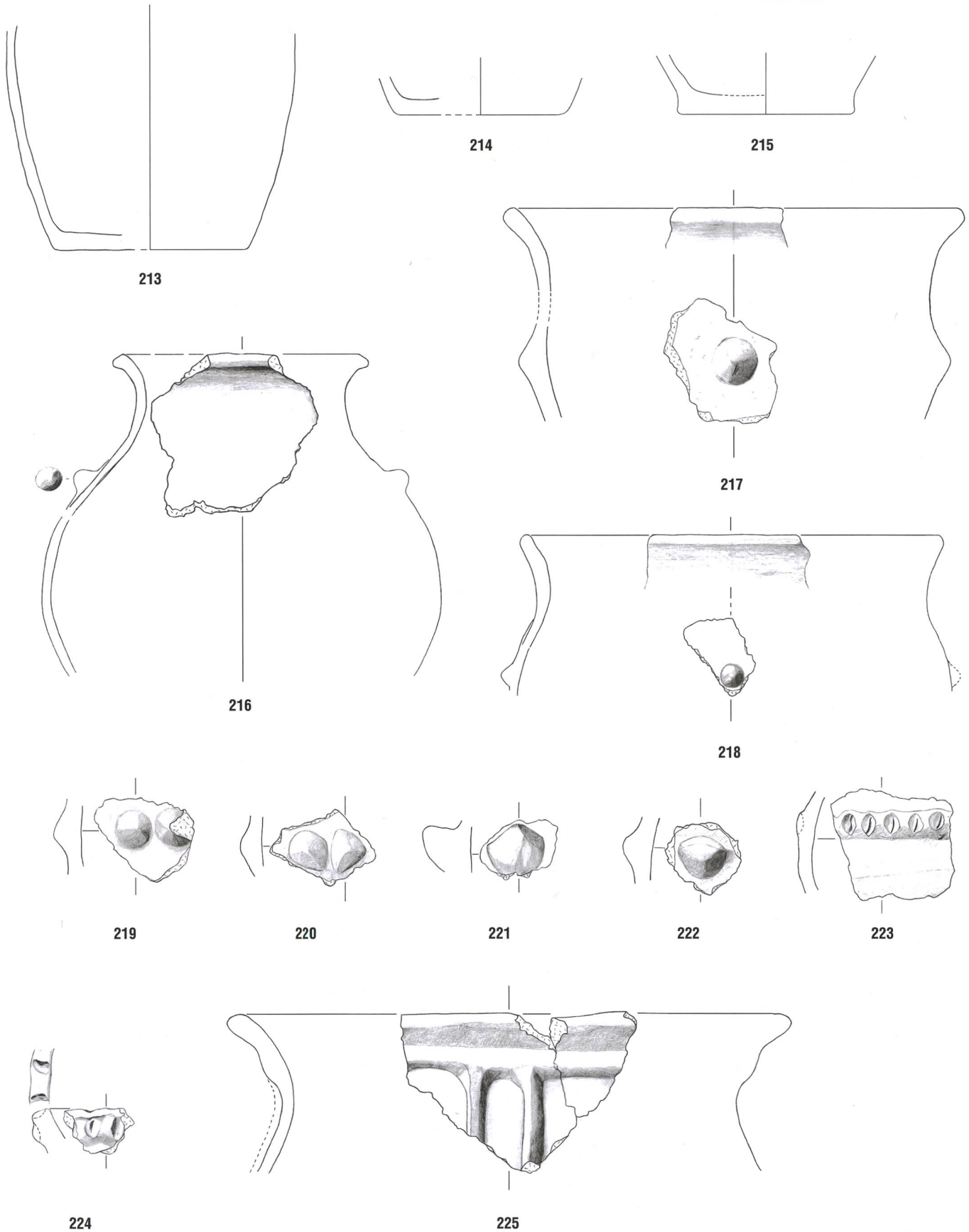

Tafel 17: Cazis, Cresta 1947–1970. Nördliche Zentralspalte, Keramikhorizont KH II. **213–223:** Planum 6N. **224–225:** Planum 7N. Keramik. Mst. 1:3.

226–232

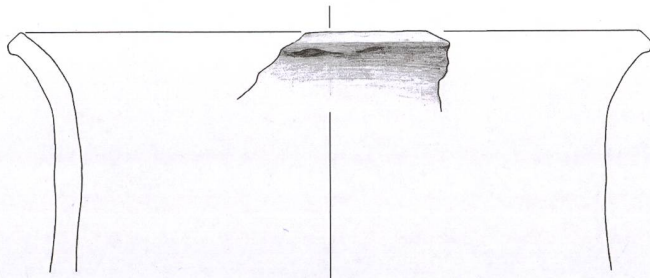

226

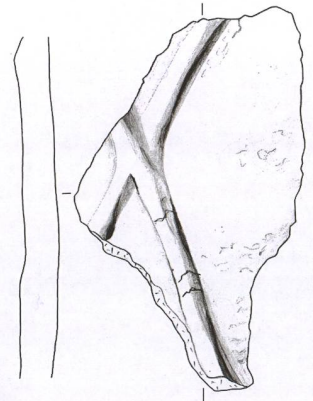

227

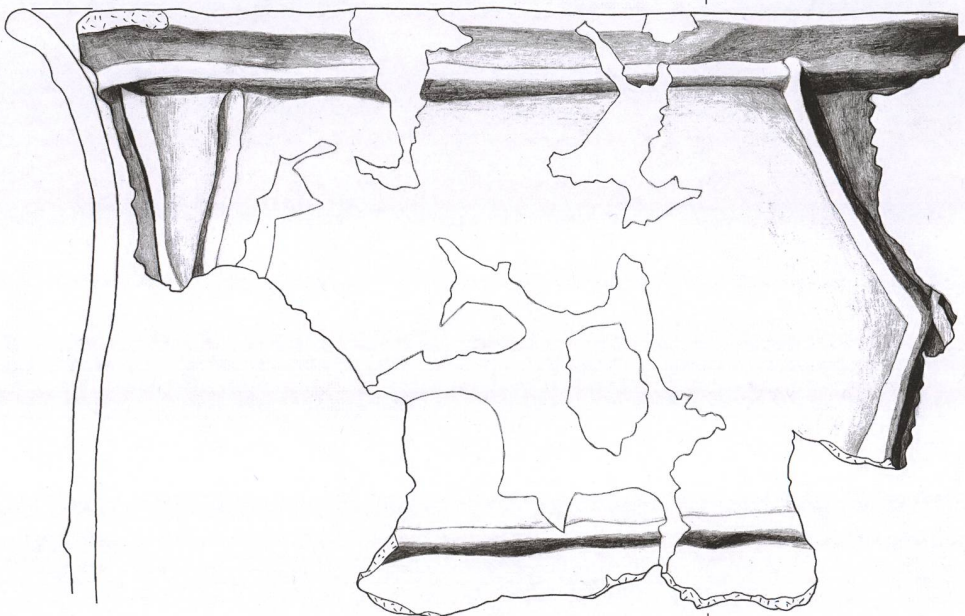

228

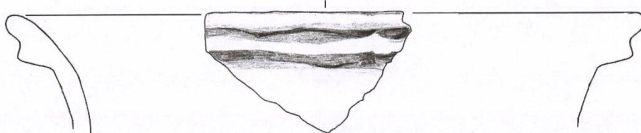

229

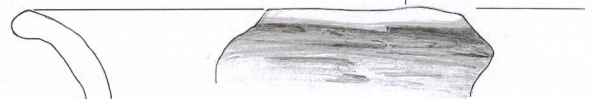

231

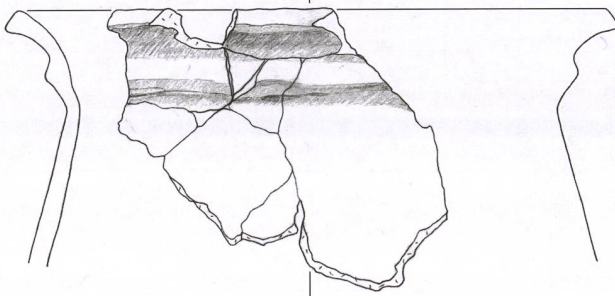

230

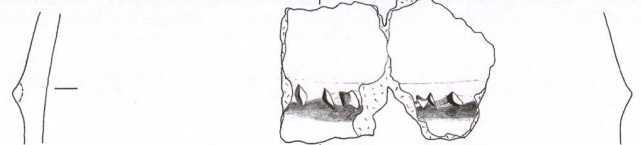

232

Tafel 18: Cazis, Cresta 1947–1970. Nördliche Zentralspalte, Keramikhorizont KH II. **226–227:** Planum 7N. **228–232:** Planum 7N oder 8N. Keramik. Mst. 1:3.

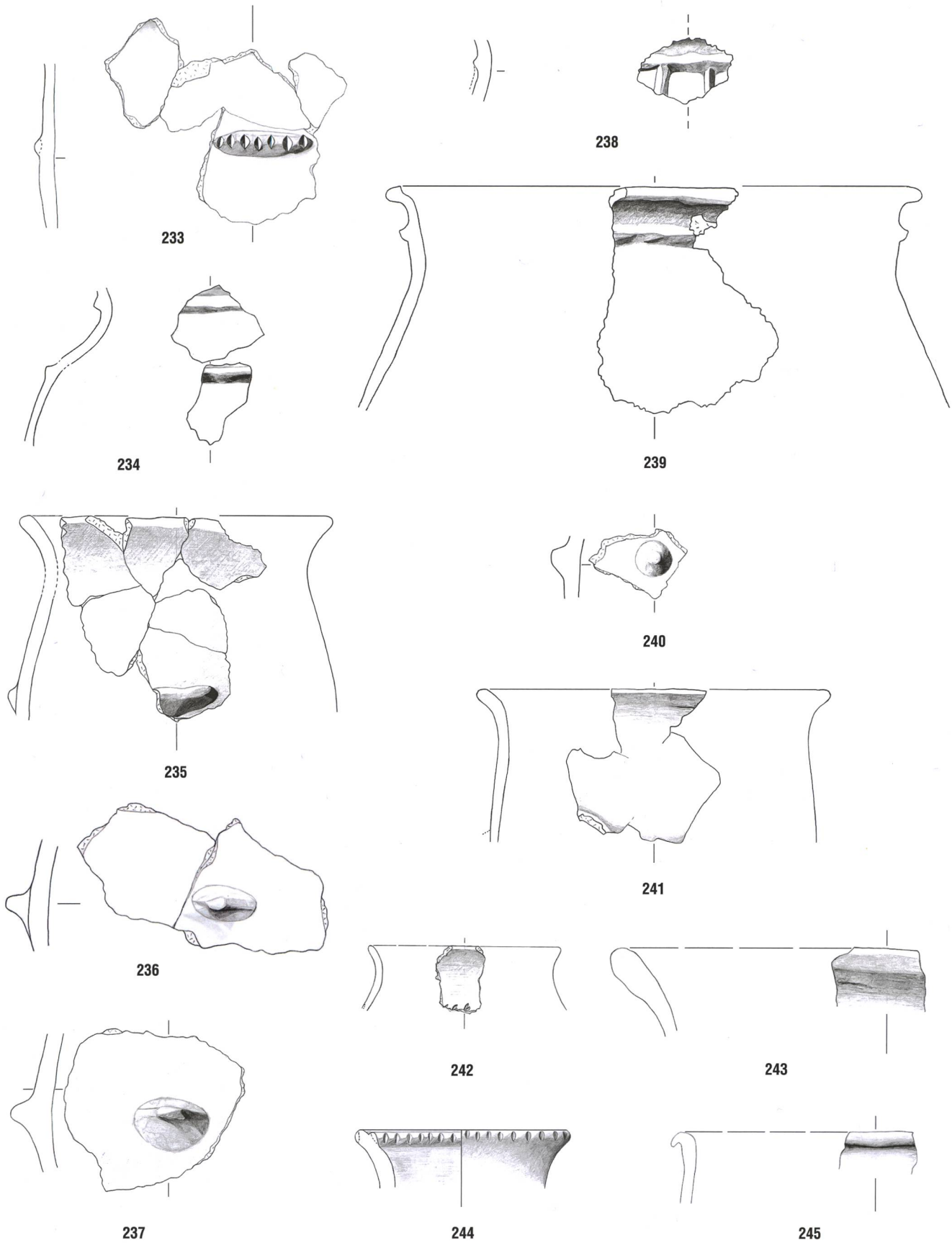

Tafel 19: Cazis, Cresta 1947–1970. Nördliche Zentralspalte, Keramikhorizont KH II. 233–235, 240–241, 243, 245: Planum 7N oder 8N. 236–237, 242, 244: Planum 7N. 238–239: Planum 8N. Keramik. Mst. 1:3.

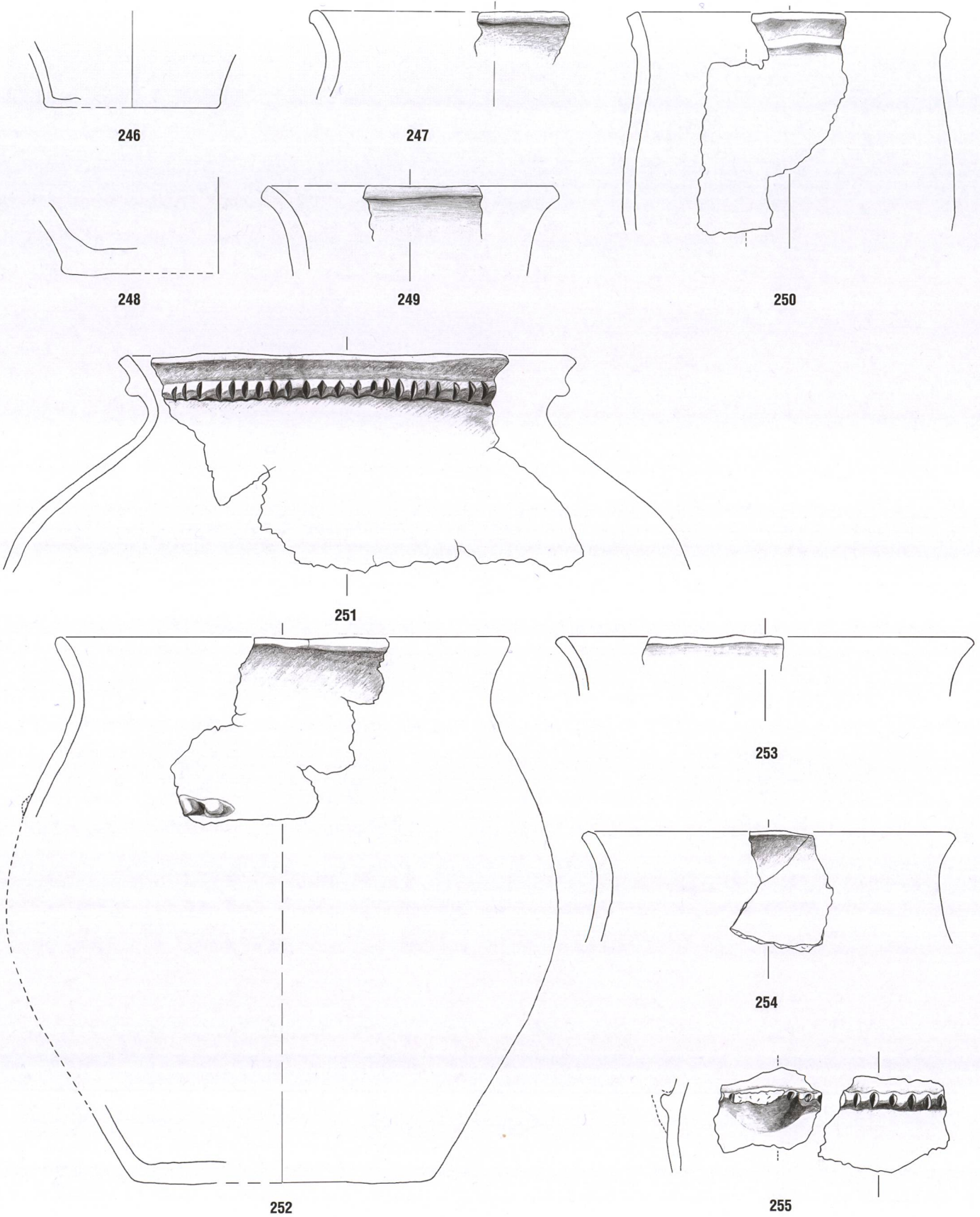

Tafel 20: Cazis, Cresta 1947–1970. Nördliche Zentralspalte, Keramikhorizont KH II. **246–247:** Planum 7N oder 8N. **248–249:** Planum 7N. **250–254:** Planum 8 N. **255:** Planum 6N. Keramik. Mst. 1:3.

256-264

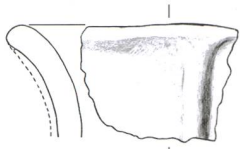

256

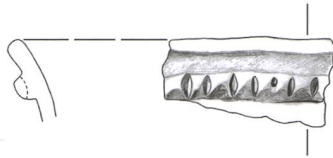

257



258



259

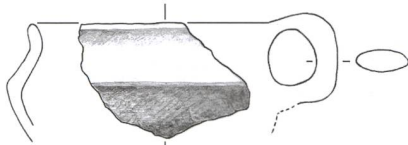

260

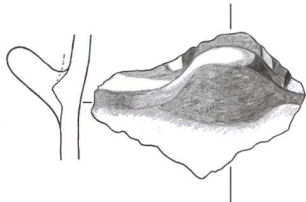
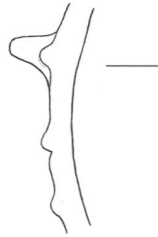

261

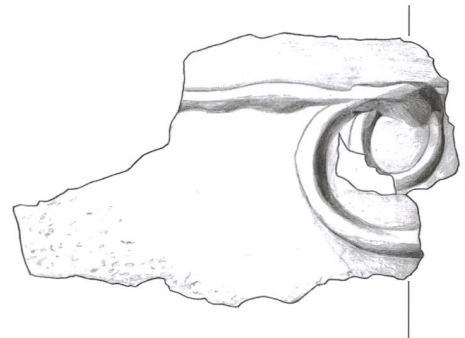

262

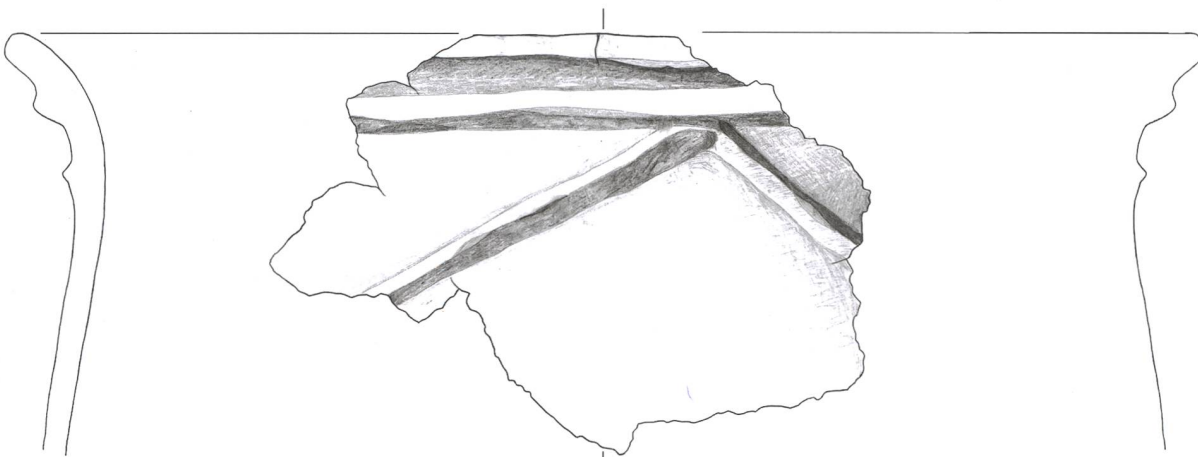

263

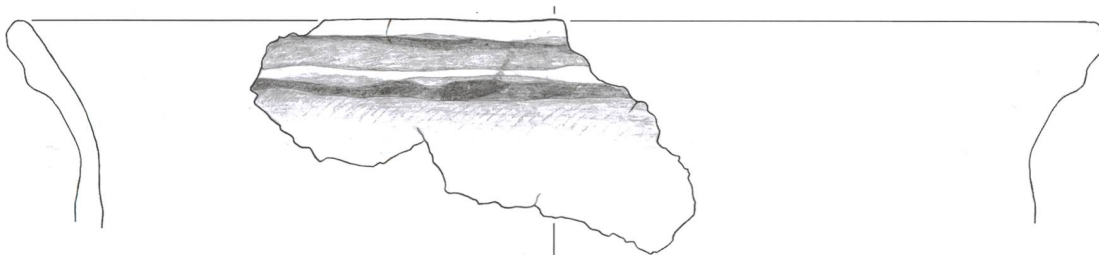

264

Tafel 21: Cazis, Cresta 1947-1970. Nördliche Zentralspalte, Keramikhorizont KH III. 256-264: Planum 9N. Keramik. Mst. 1:3.

265-274

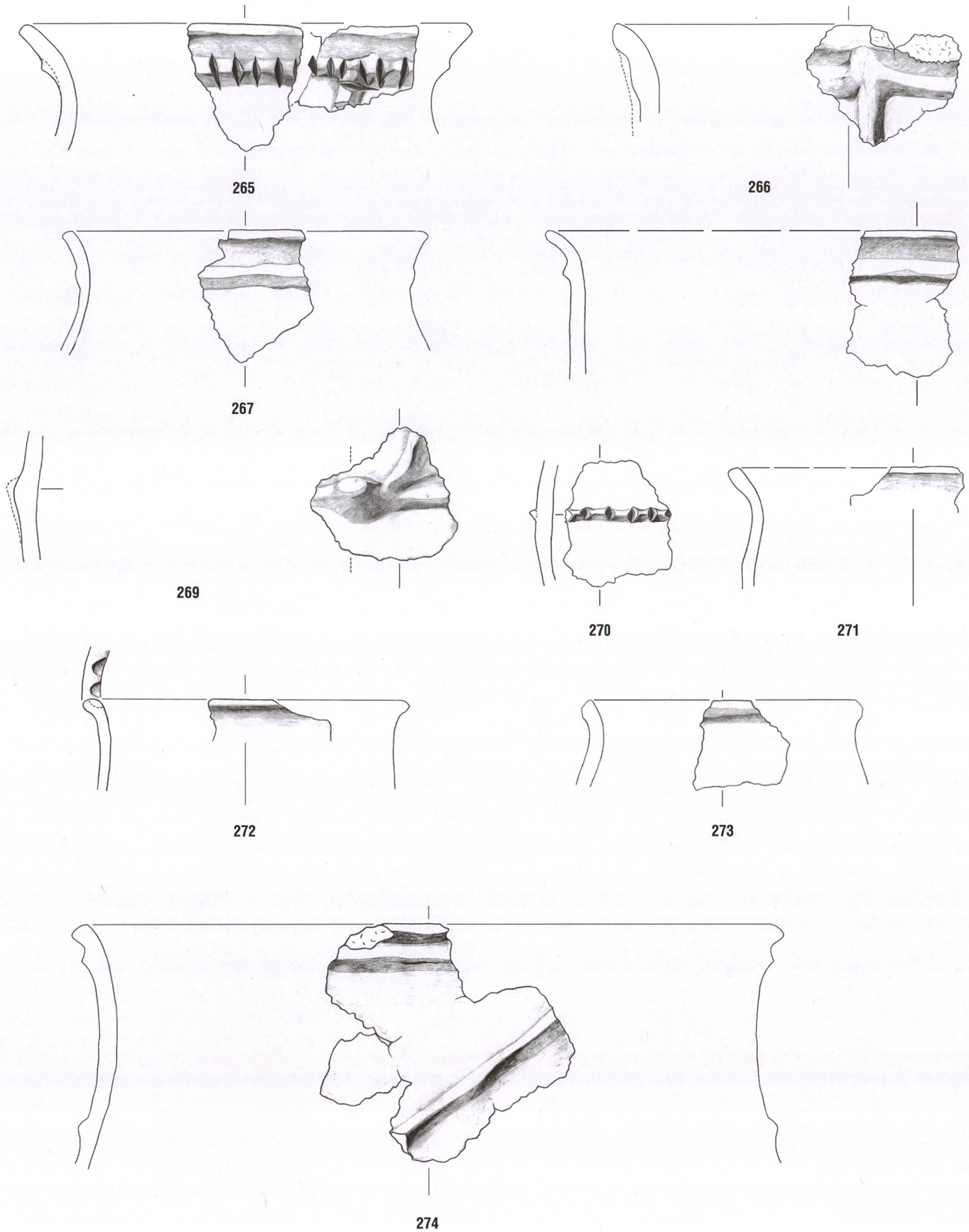

Tafel 22: Cazis, Cresta 1947-1970. Nördliche Zentralspalte, Keramikhorizont KH III. 265-272: Planum 9N. 273-274: Planum 10N. Keramik. Mst. 1:3.

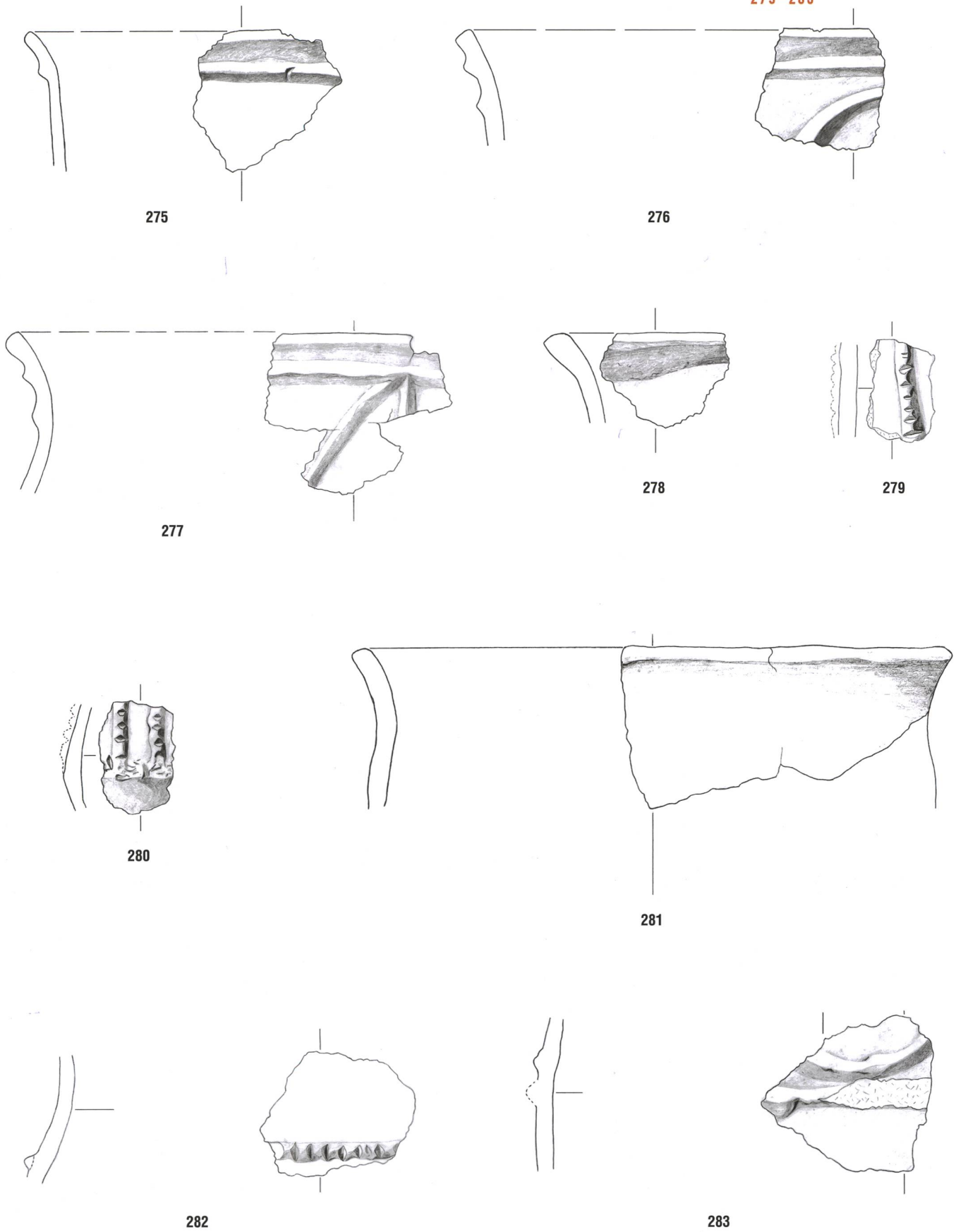

Tafel 23: Cazis, Cresta 1947–1970. Nördliche Zentralspalte, Keramikhorizont KH III. **275–280, 282–283:** Planum 10N. **281:** Plana 8N–10N. Keramik. Mst. 1:3.

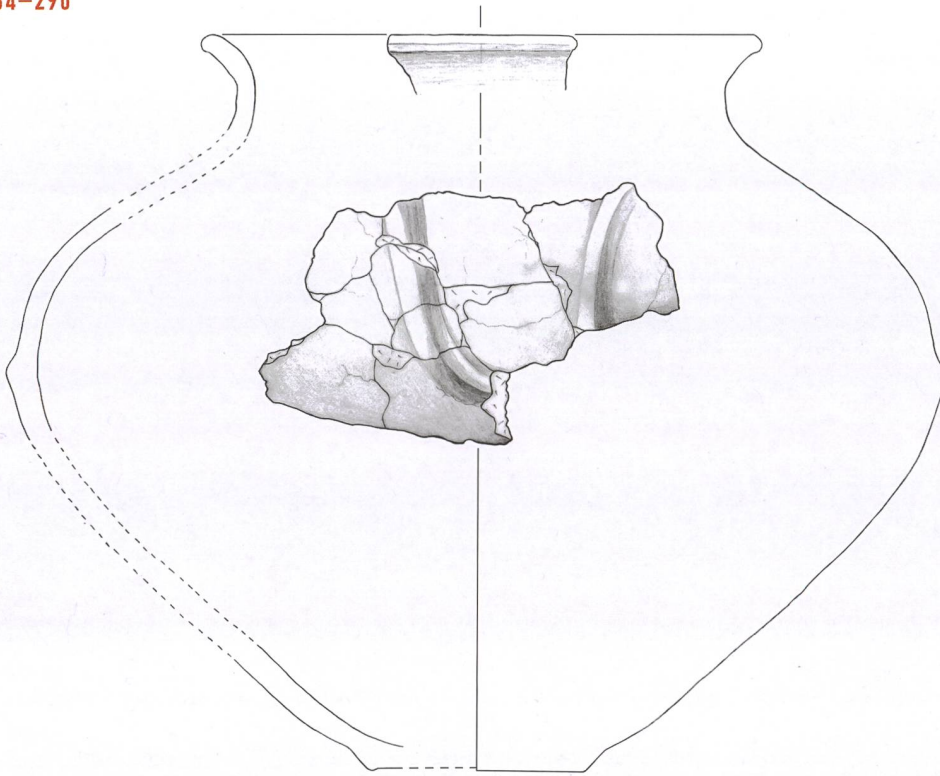

284

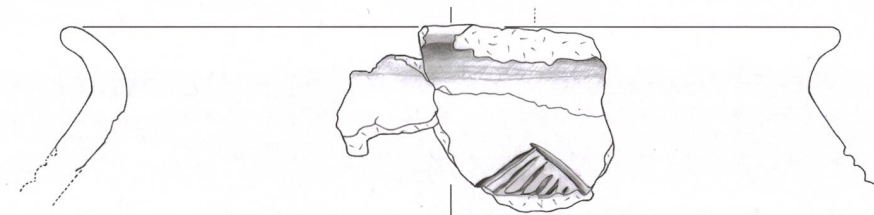

285

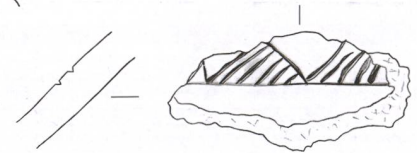

286



287

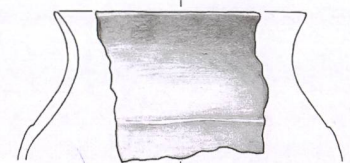

289

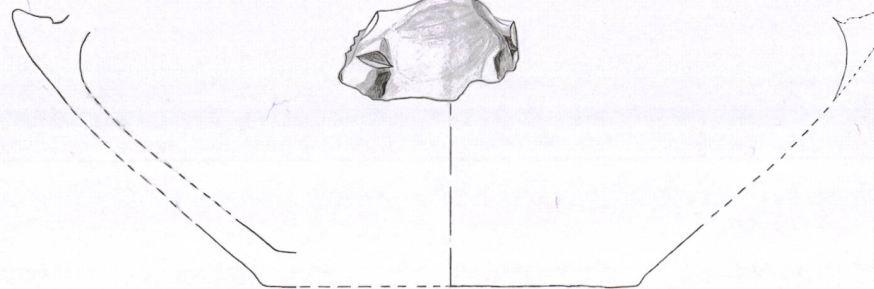

288

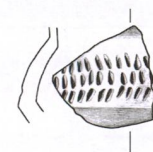

290

Tafel 24: Cazis, Cresta 1947-1970. Nördliche Zentralspalte, Keramikhorizont KH III. **284, 286-290:** Planum 10N. **285:** Plana 8N-10N. Keramik. Mst. 1:3.

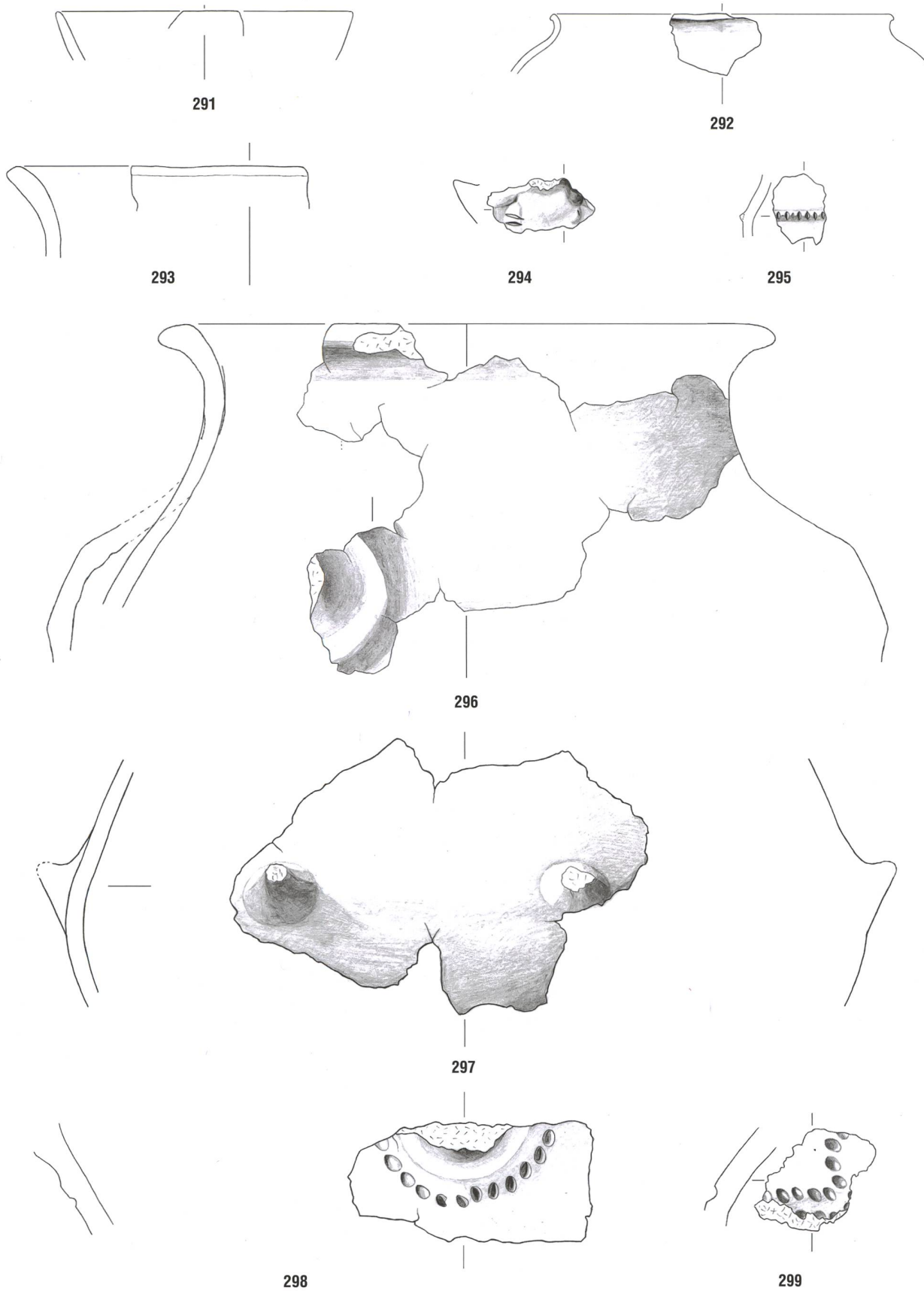

Tafel 25: Cazis, Cresta 1947–1970. Nördliche Zentralspalte, Keramikhorizont KH III. 291–297: Planum 10N. 298–299: Planum 11N. Keramik. Mst. 1:3.

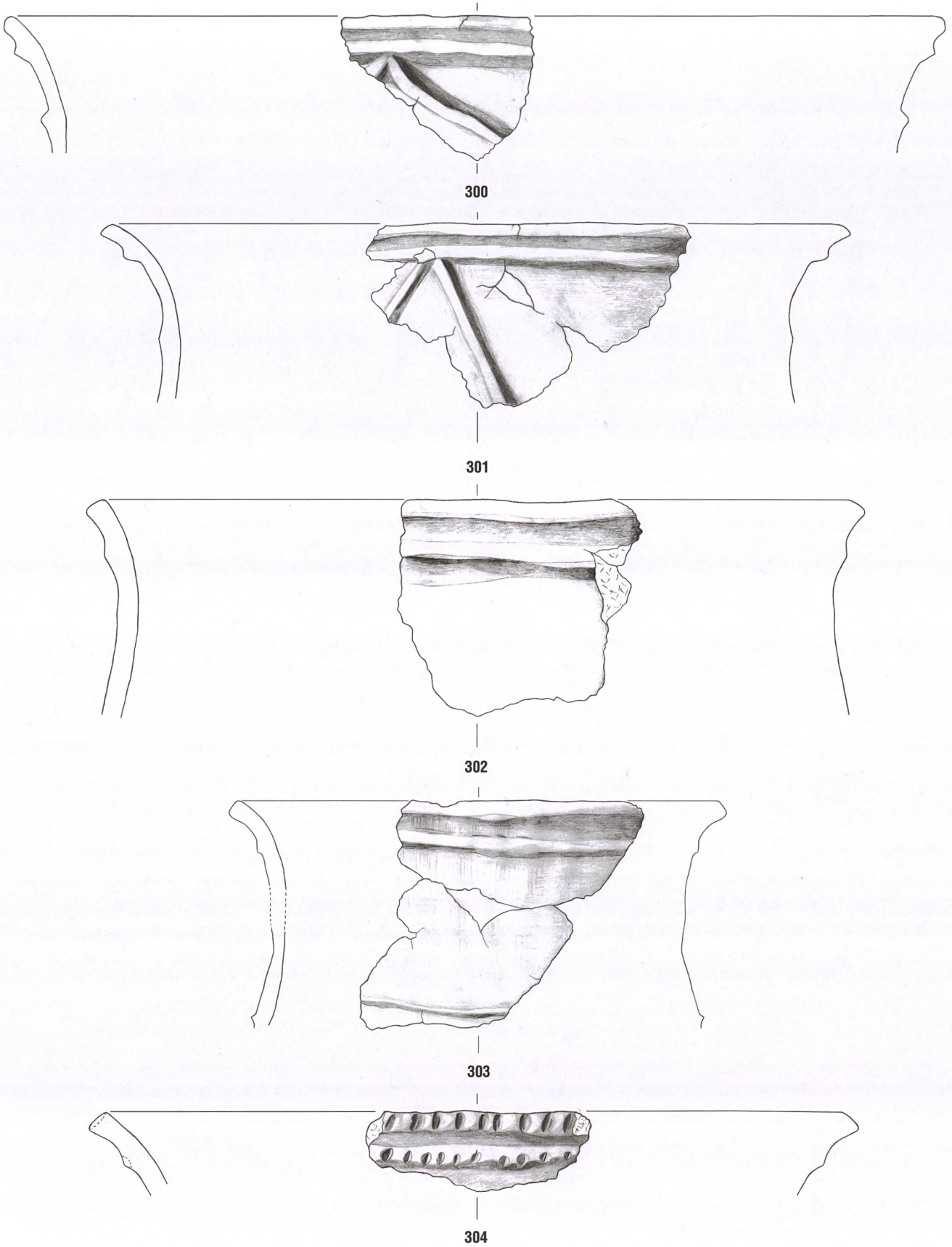

Tafel 26: Cazis, Cresta 1947-1970. Nördliche Zentralspalte, Keramikhorizont KH III. 300-304: Planum 11N. Keramik. Mst. 1:3.

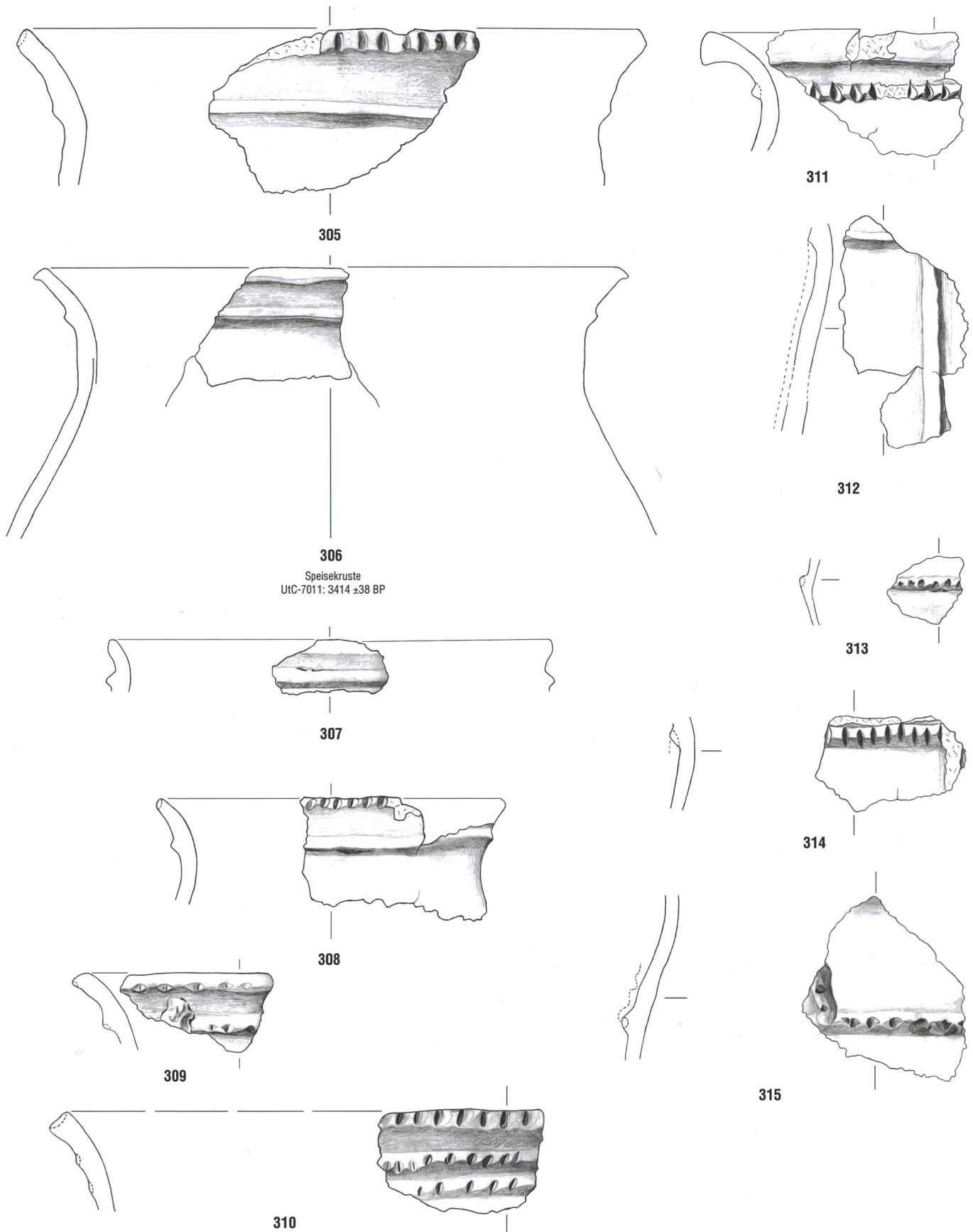

Tafel 27: Cazis, Cresta 1947–1970. Nördliche Zentralspalte, Keramikhorizont KH III. 305–315: Planum 11N. Keramik. Mst. 1:3.

316–326

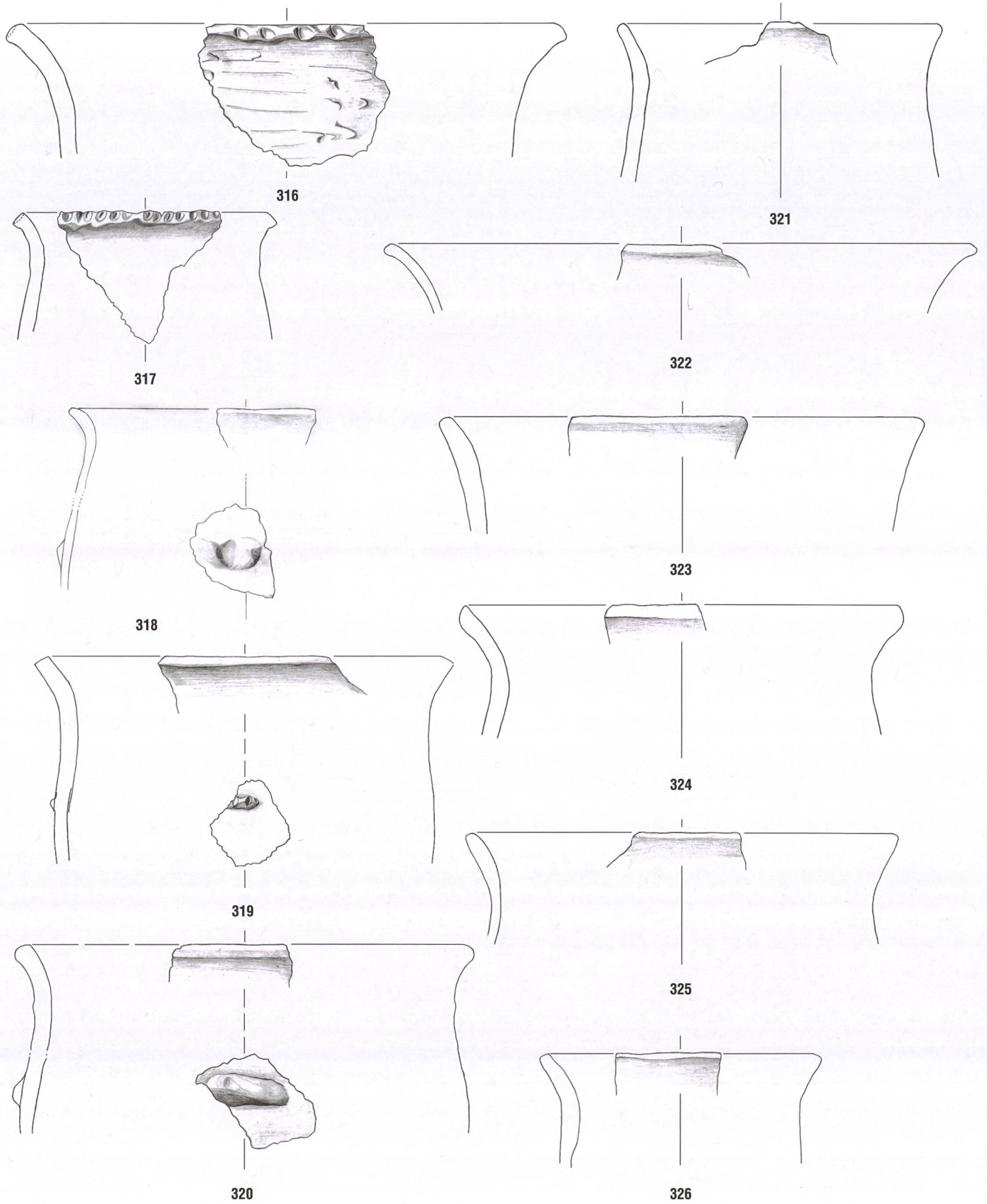

Tafel 28: Cazis, Cresta 1947–1970. Nördliche Zentralspalte, Keramikhorizont KH III. 316–321, 323–326: Planum 11N. 322: Plana 10N–11N. Keramik. Mst. 1:3.

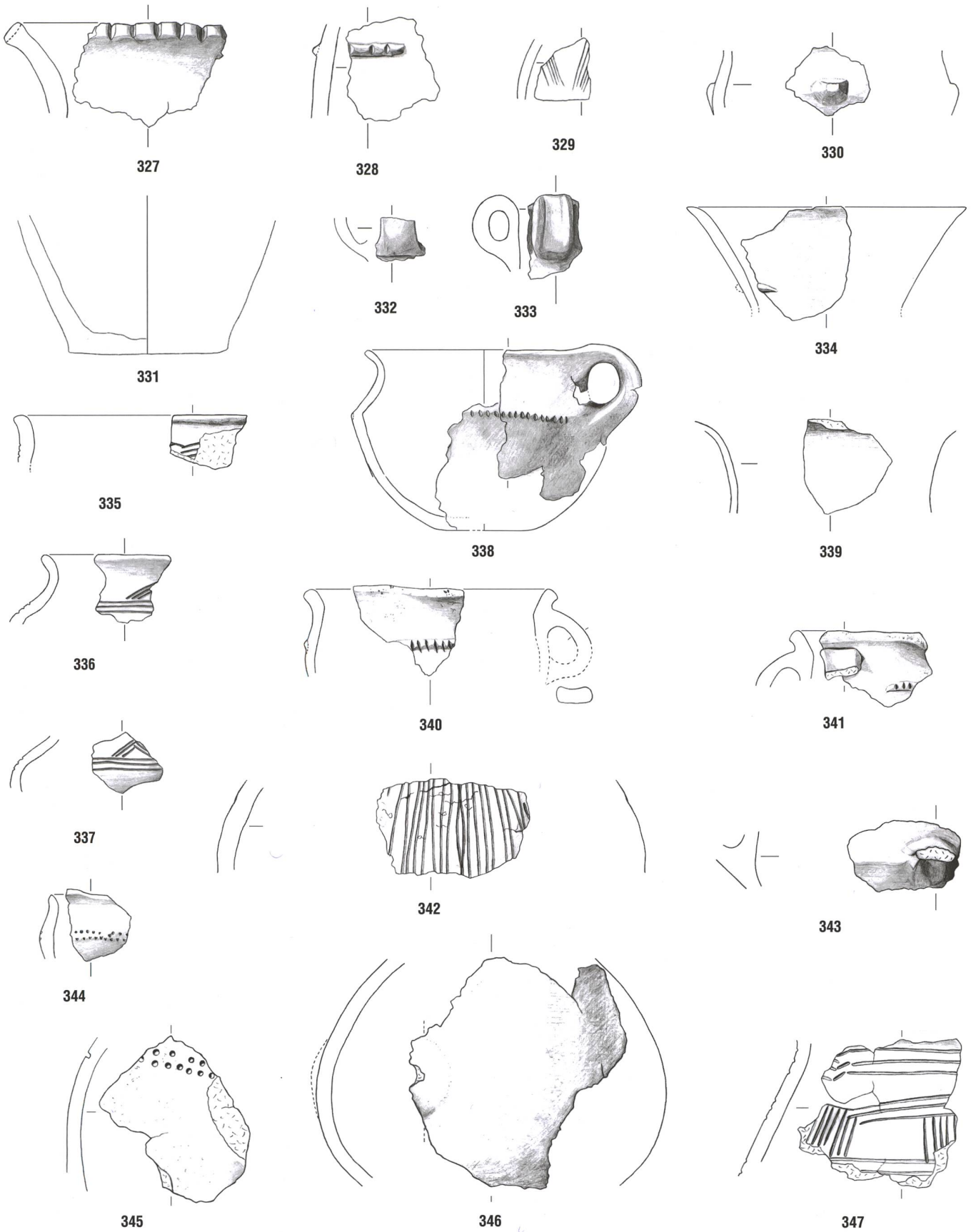

Tafel 29: Cazis, Cresta 1947–1970. Nördliche Zentralspalte, Keramikhorizont KH III. 327–334: Planum 11N. 335–337, 339–347: Planum 12N. 338: Plana 11N–12N. Keramik. Mst. 1:3.

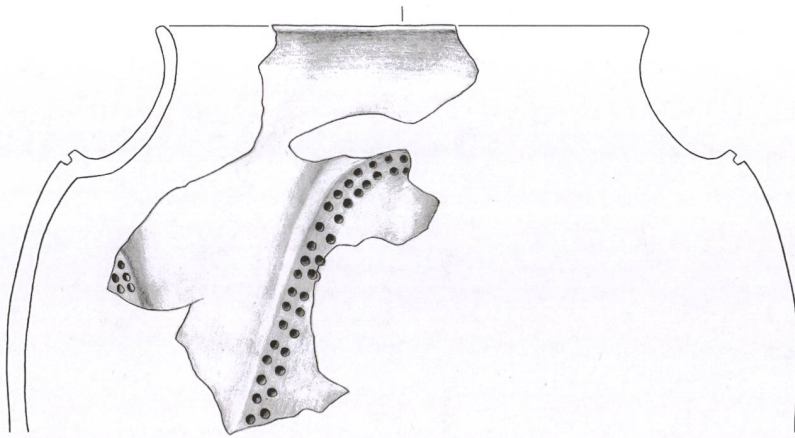

348

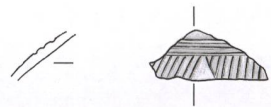

349



350

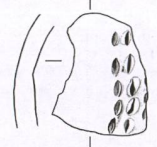

351

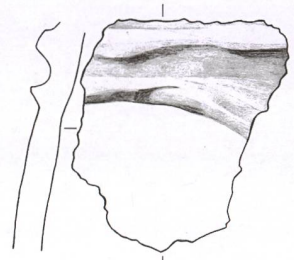

353

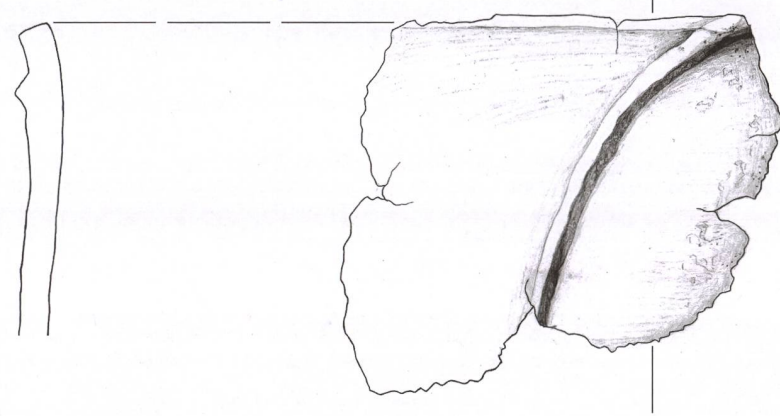

352

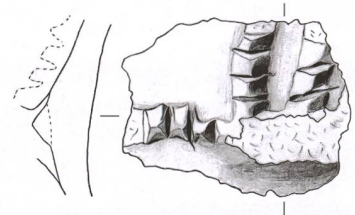

354

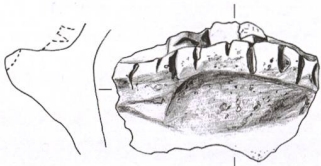

355

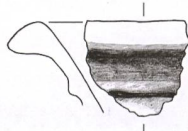

356

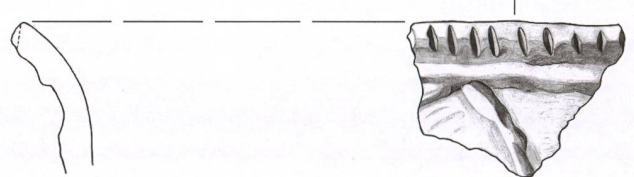

357

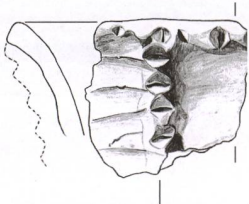

358

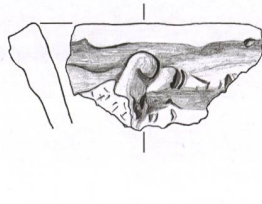

359

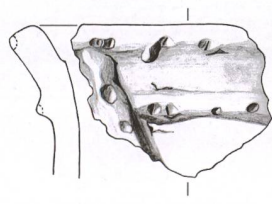

360

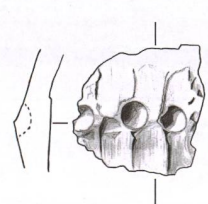

361

Tafel 30: Cazis, Cresta 1947-1970. Nördliche Zentralspalte, Keramikhorizont KH III. 348-361: Planum 12N. Keramik. Mst. 1:3.

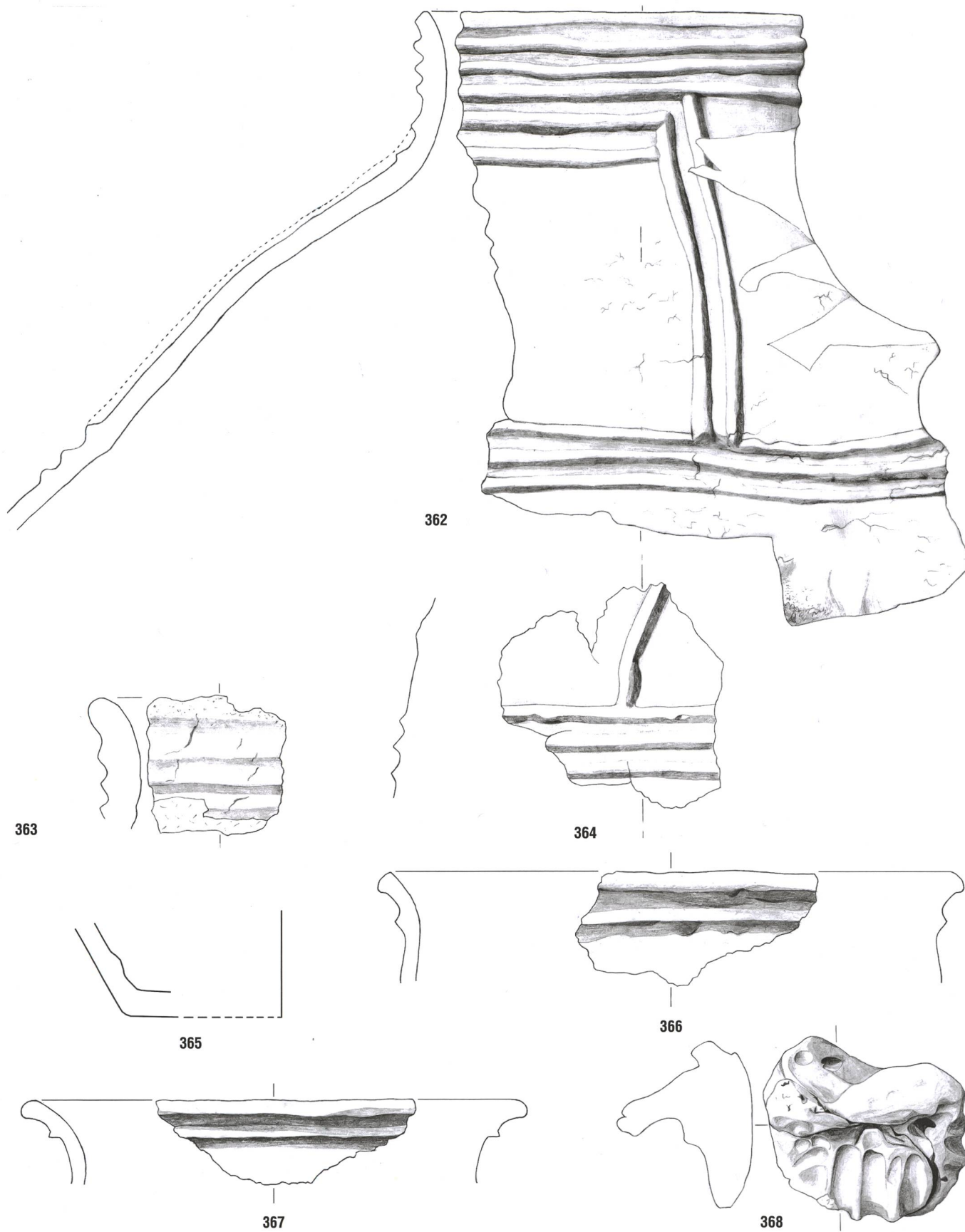

Tafel 31: Cazis, Cresta 1947–1970. Nördliche Zentralspalte, Keramikhorizont KH III. 362–368: Planum 12N. Keramik. Mst. 1:3.

369-381

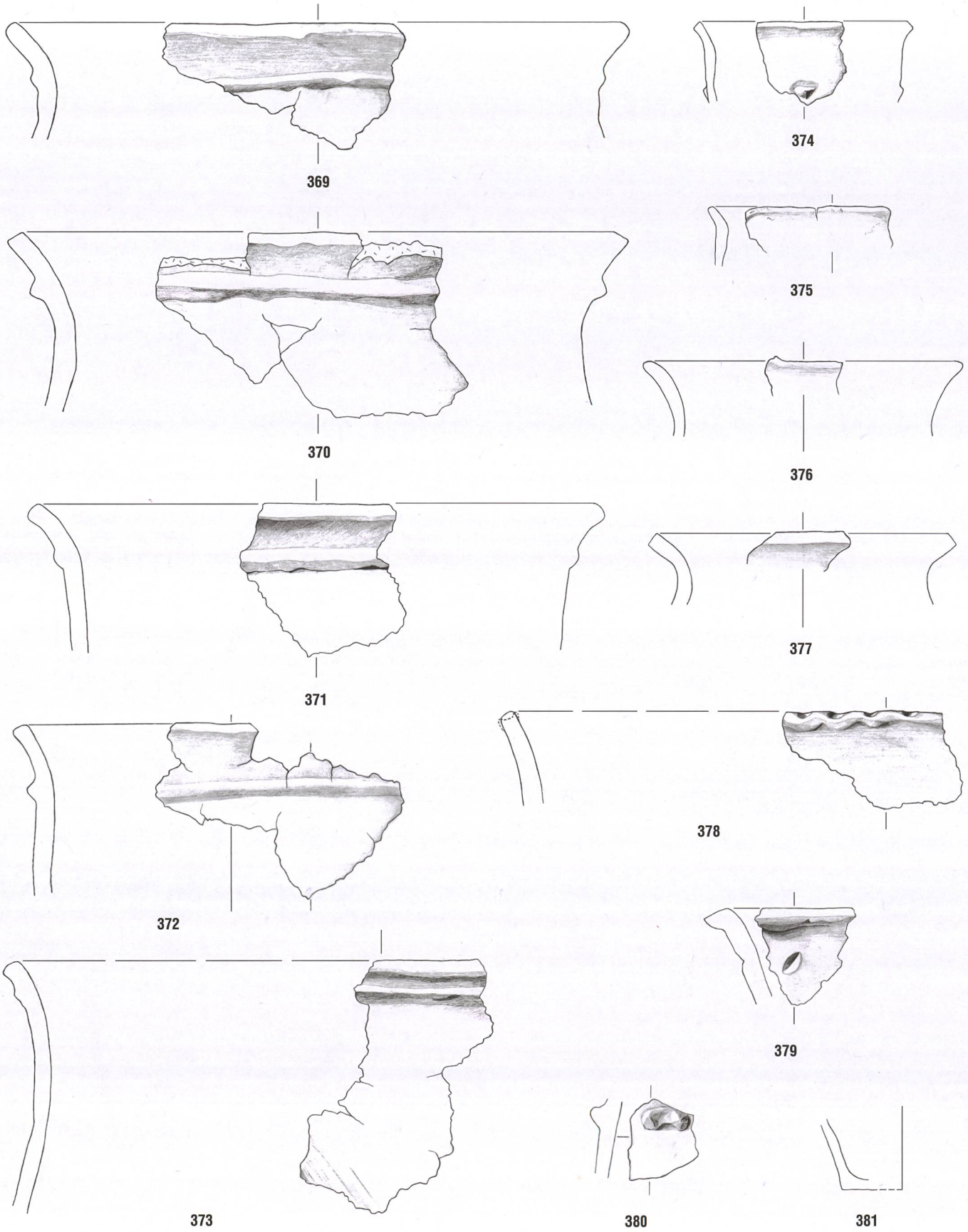

Tafel 32: Cazis, Cresta 1947-1970. Nördliche Zentralspalte, Keramikhorizont KH III. 369-381: Planum 12N. Keramik. Mst. 1:3.

382-391



382

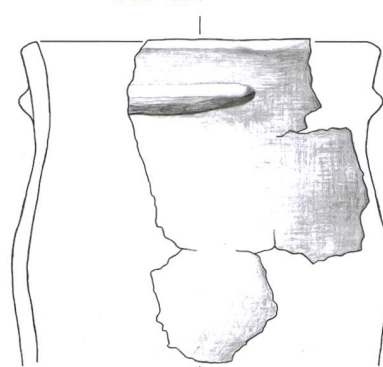

387



383



388

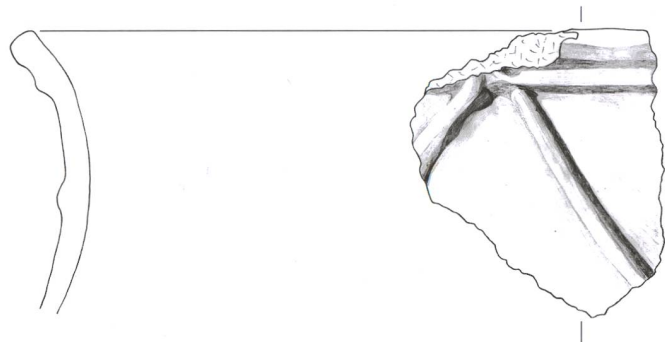

384

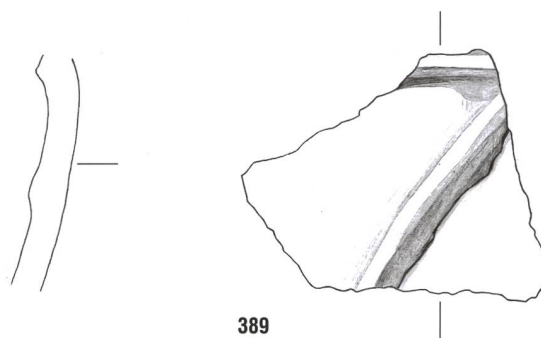

389

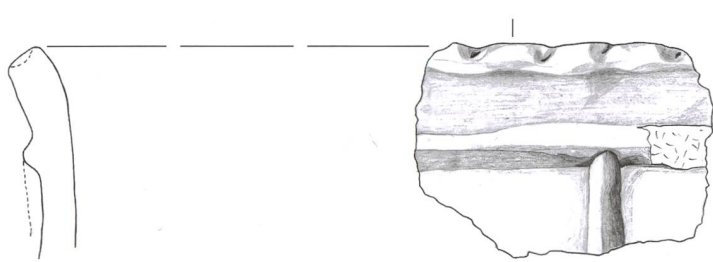

385

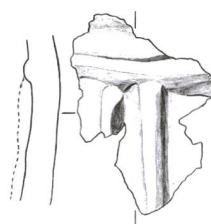

390

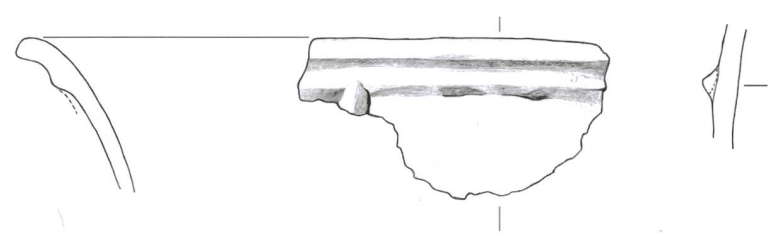

386

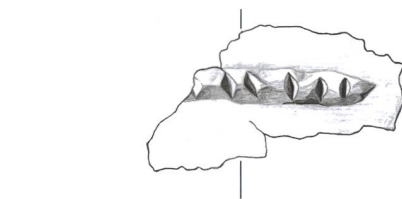

391

Tafel 33: Cazis, Cresta 1947-1970. Nördliche Zentralspalte, Keramikhorizont KH III. 382-391: Planum 12N. Keramik. Mst. 1:3.

392-403

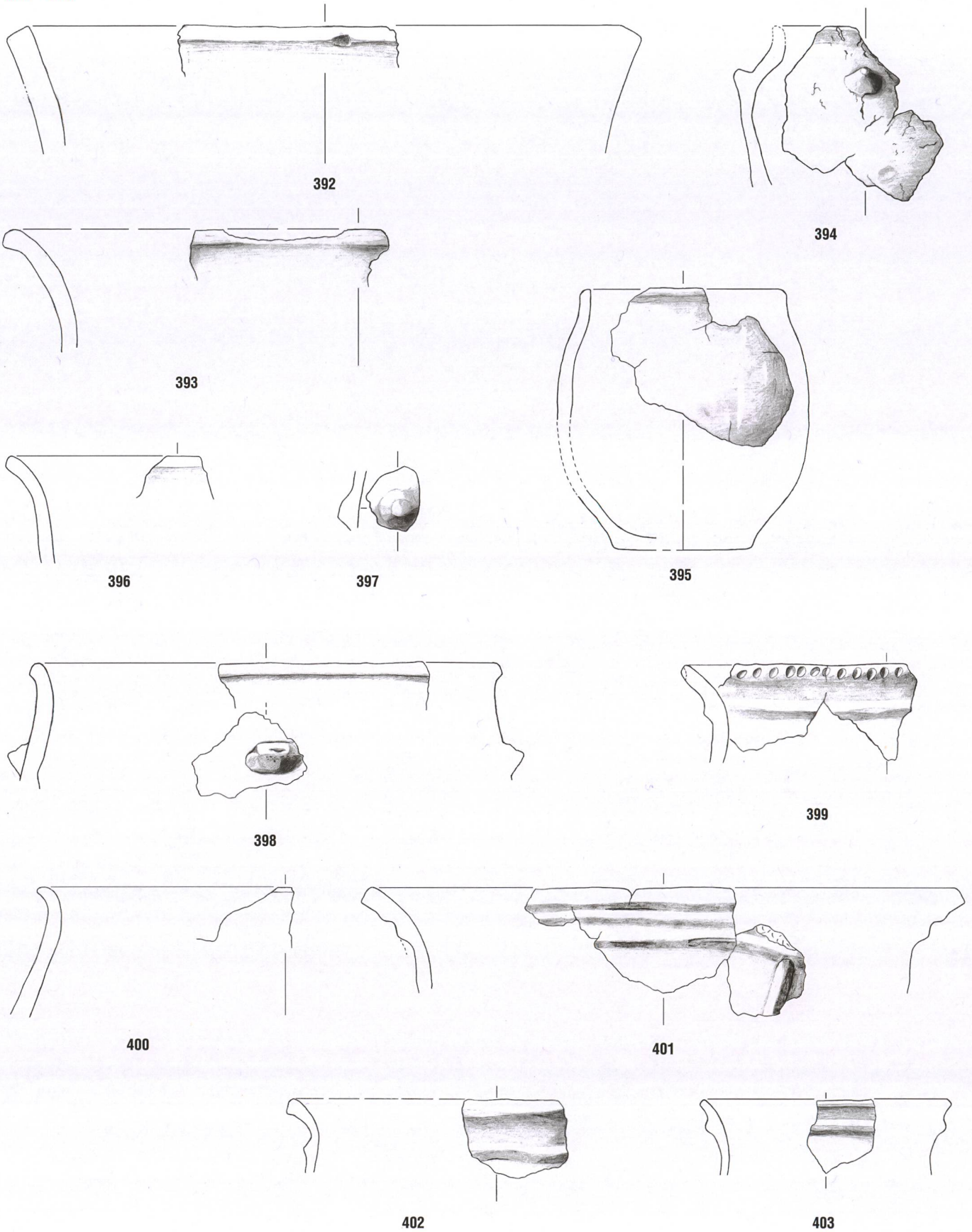

Tafel 34: Cazis, Cresta 1947-1970. Nördliche Zentralspalte, Keramikhorizont KH III. 392-395: Planum 12N. 396-403: Planum 13N. Keramik. Mst. 1:3.

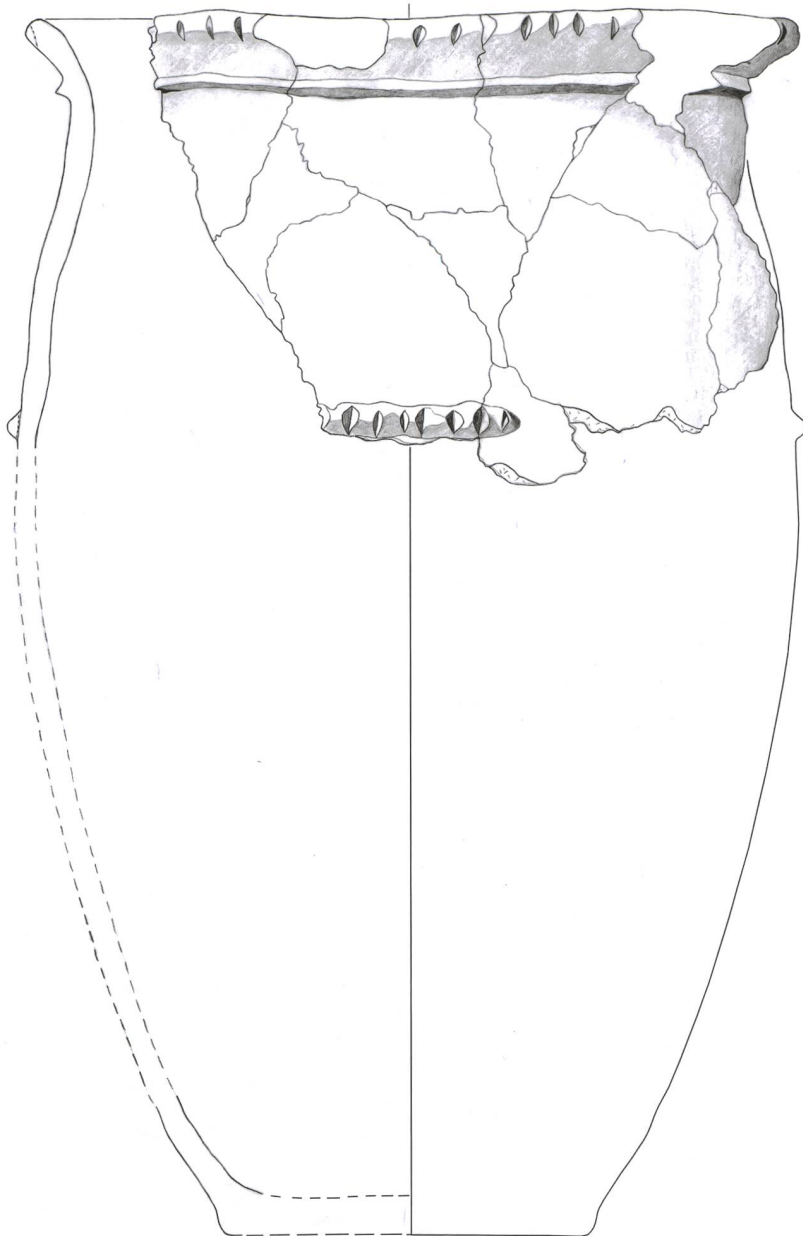

404

404-414

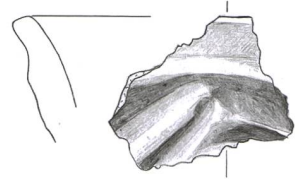

405

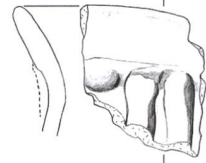

406

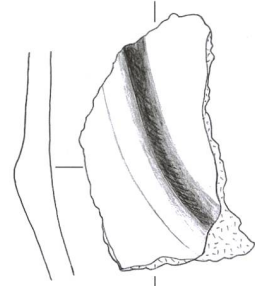

407

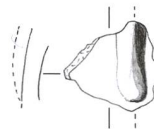

408

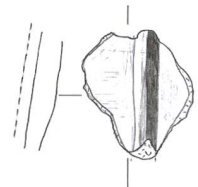

409

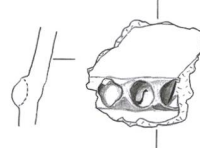

411

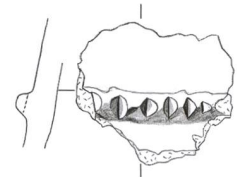

412

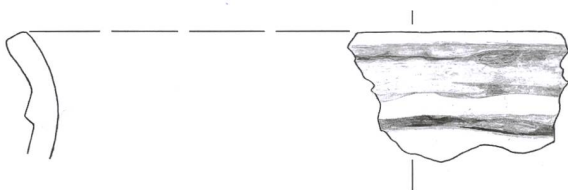

410

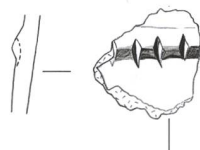

413

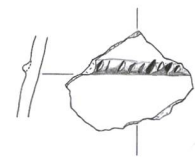

414

Tafel 35: Cazis, Cresta 1947–1970. Nördliche Zentralspalte, Keramikhorizont KH III. Aus dem gestörten Bereich der Felder 17 und 18. 404, 412: Zwischen Planum 8N und Planum 9N. 405–411, 413–414: Planum 9N. Keramik. Mst. 1:3.

415-434

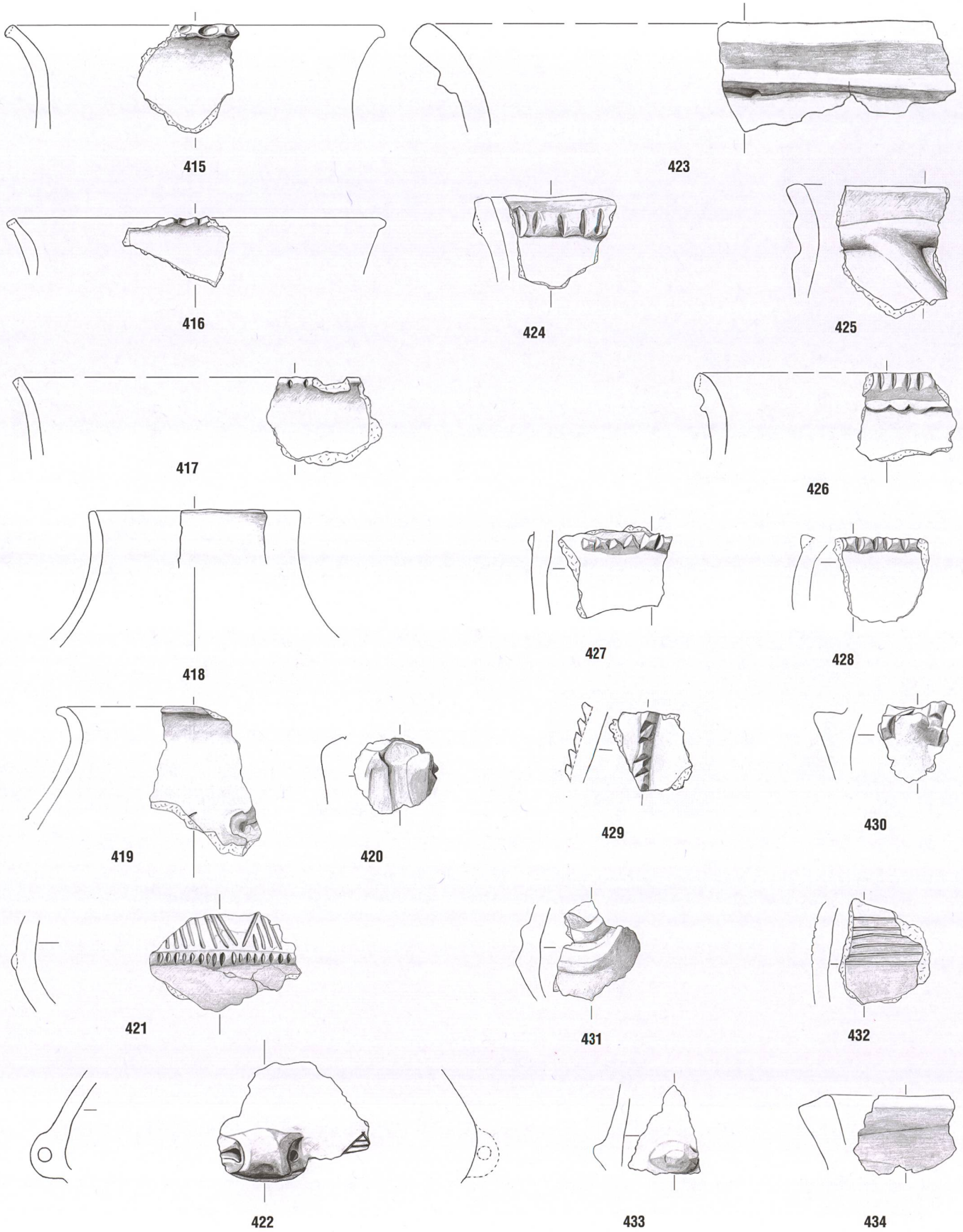

Tafel 36: Cazis, Cresta 1947-1970. Nördliche Zentralspalte, Keramikhorizont KH III. Aus dem gestörten Bereich der Felder 17 und 18. 415-434: Planum 8N. Keramik. Mst. 1:3.



435-450

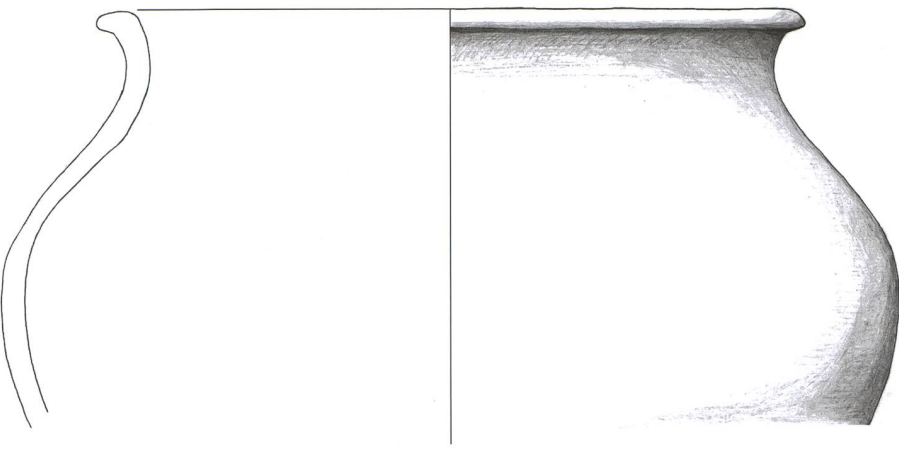

Speisekruste
UTC-8085: 3580 ±220 BP

435

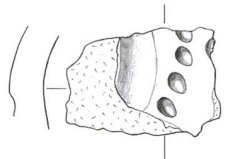

440

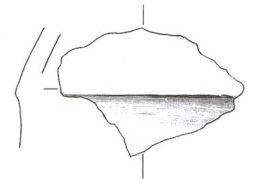

441

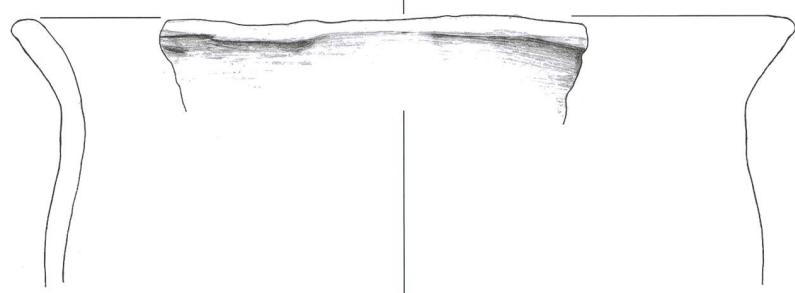

436

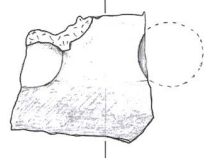
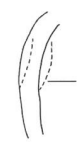

442



443

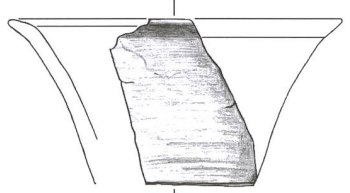

444

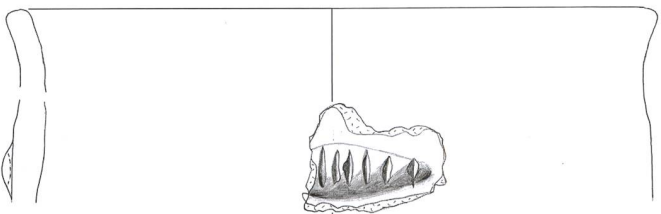

437

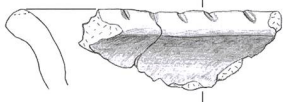

445



446

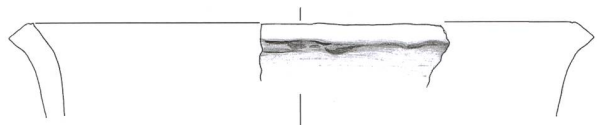

438

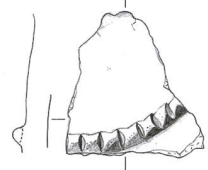

447

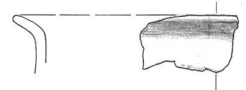

448

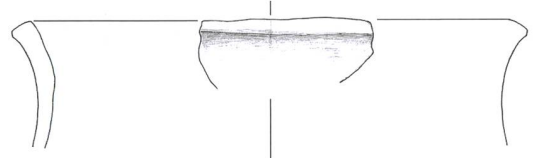

439

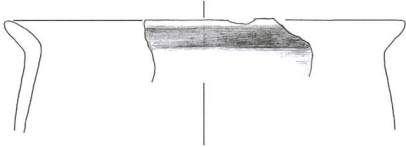

449

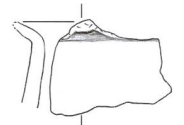

450

Tafel 37: Cazis, Cresta 1947-1970. Nördliche Zentralspalte, Keramikhorizont KH III. Aus dem gestörten Bereich der Felder 17 und 18. 435-437, 446-447: Plana 8N-12N. 438: Planum 10N. 439-445, 448-450: Planum 9N. Keramik. Mst. 1:3.

451-468

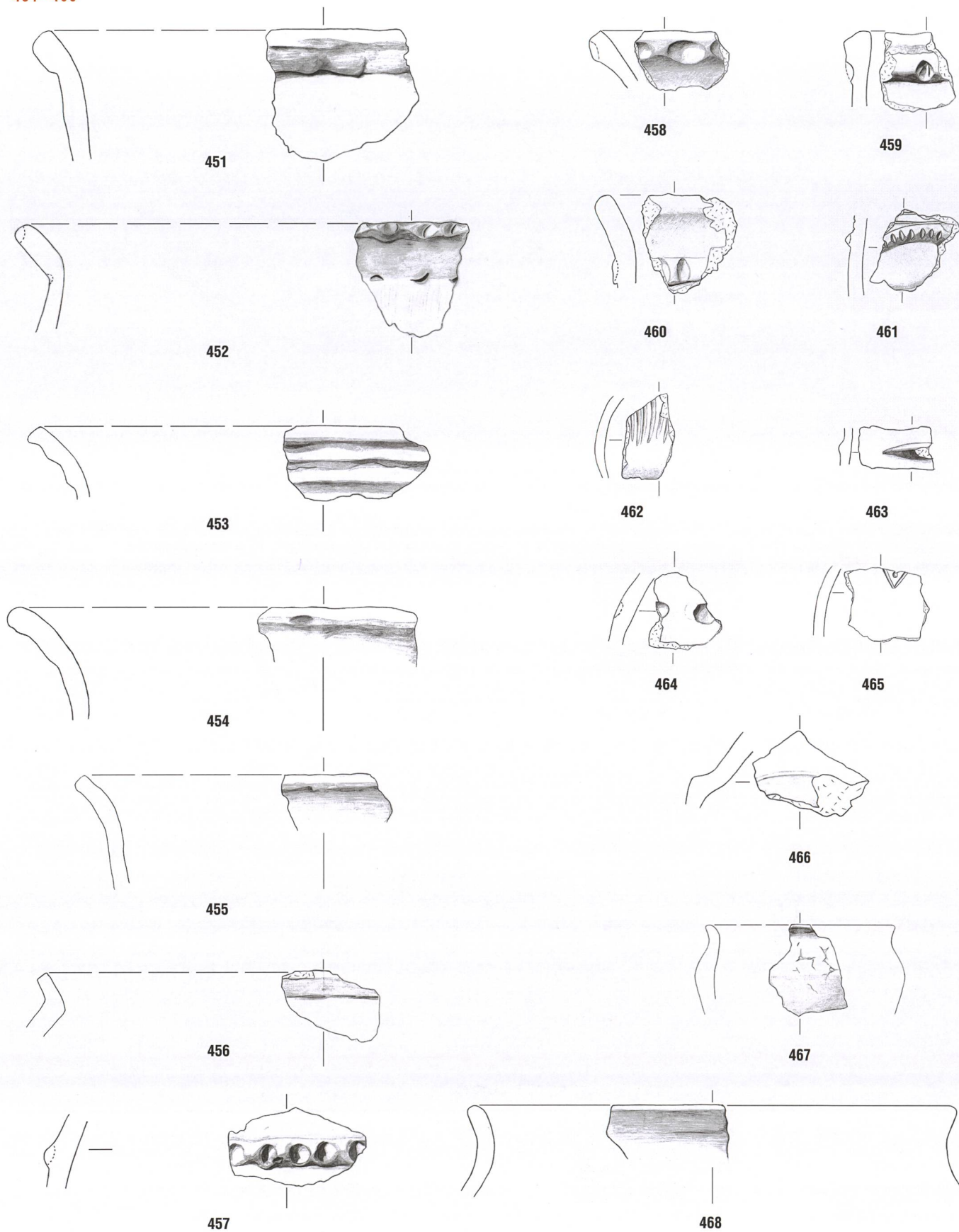

Tafel 38: Cazis, Cresta 1947-1970. Nördliche Zentralspalte, Keramikhorizont KH IV. Aus dem gestörten Bereich der Felder 17 und 18. 451-468: Planum 9N. Keramik. Mst. 1:3.

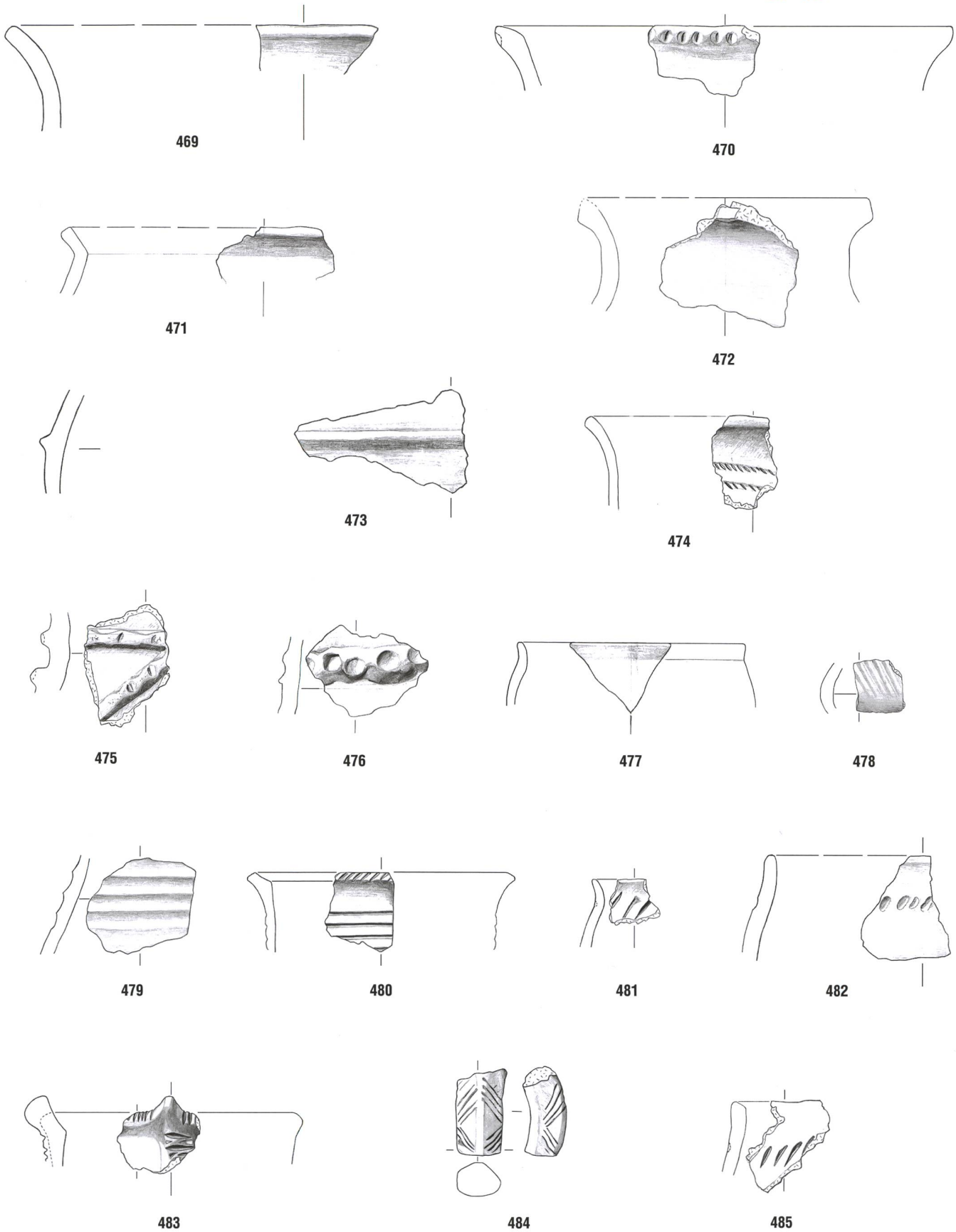

Tafel 39: Cazis, Cresta 1947–1970. Nördliche Zentralspalte, Keramikhorizont KH IV. Aus dem gestörten Bereich der Felder 17 und 18. **469–470:** Planum 9N. **471–481:** Planum 10N. **483–484:** Plana 10N–11N. **482, 485:** Planum 11N. Keramik. Mst. 1:3.

486-497

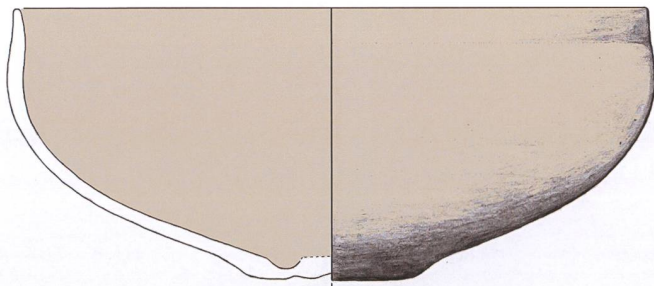

486

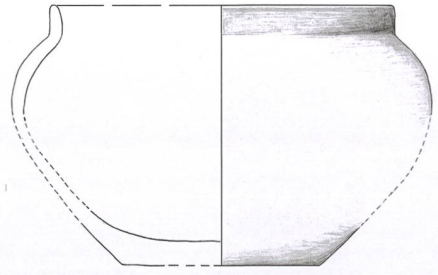

490



491

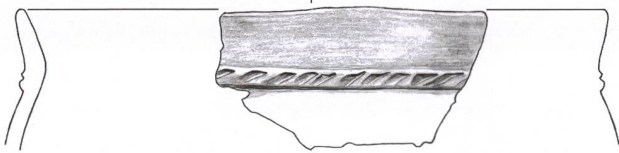

487

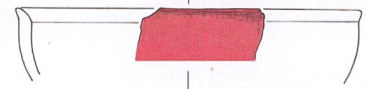

492

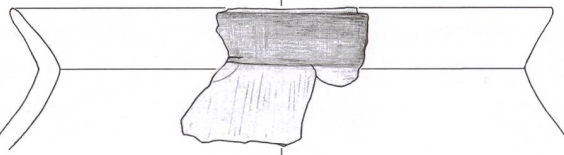

488

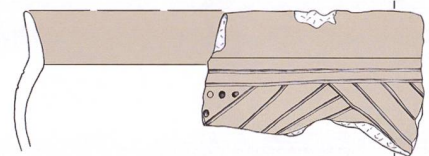

493



494

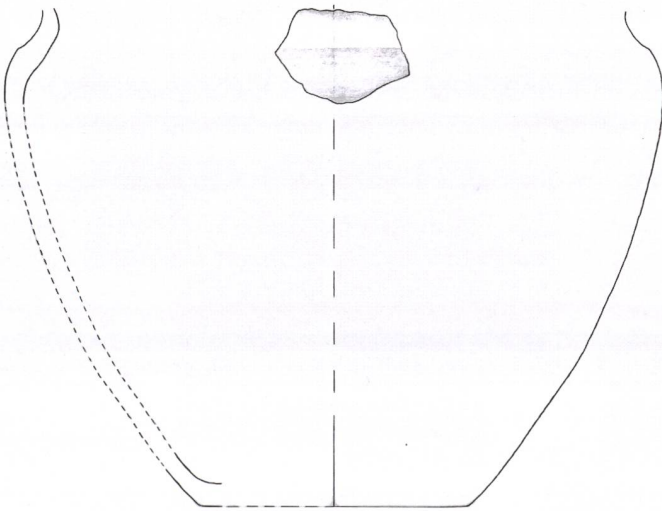

489



495

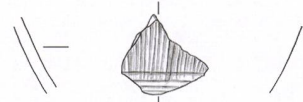

496

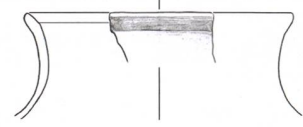

497

Tafel 40: Cazis, Cresta 1947-1970. Nördliche Zentralspalte, Keramikhorizont KH IV. Aus dem gestörten Bereich der Felder 17 und 18. 486-496: Planum 11N. 497: Plana 10N-11N. Keramik. Mst. 1:3.

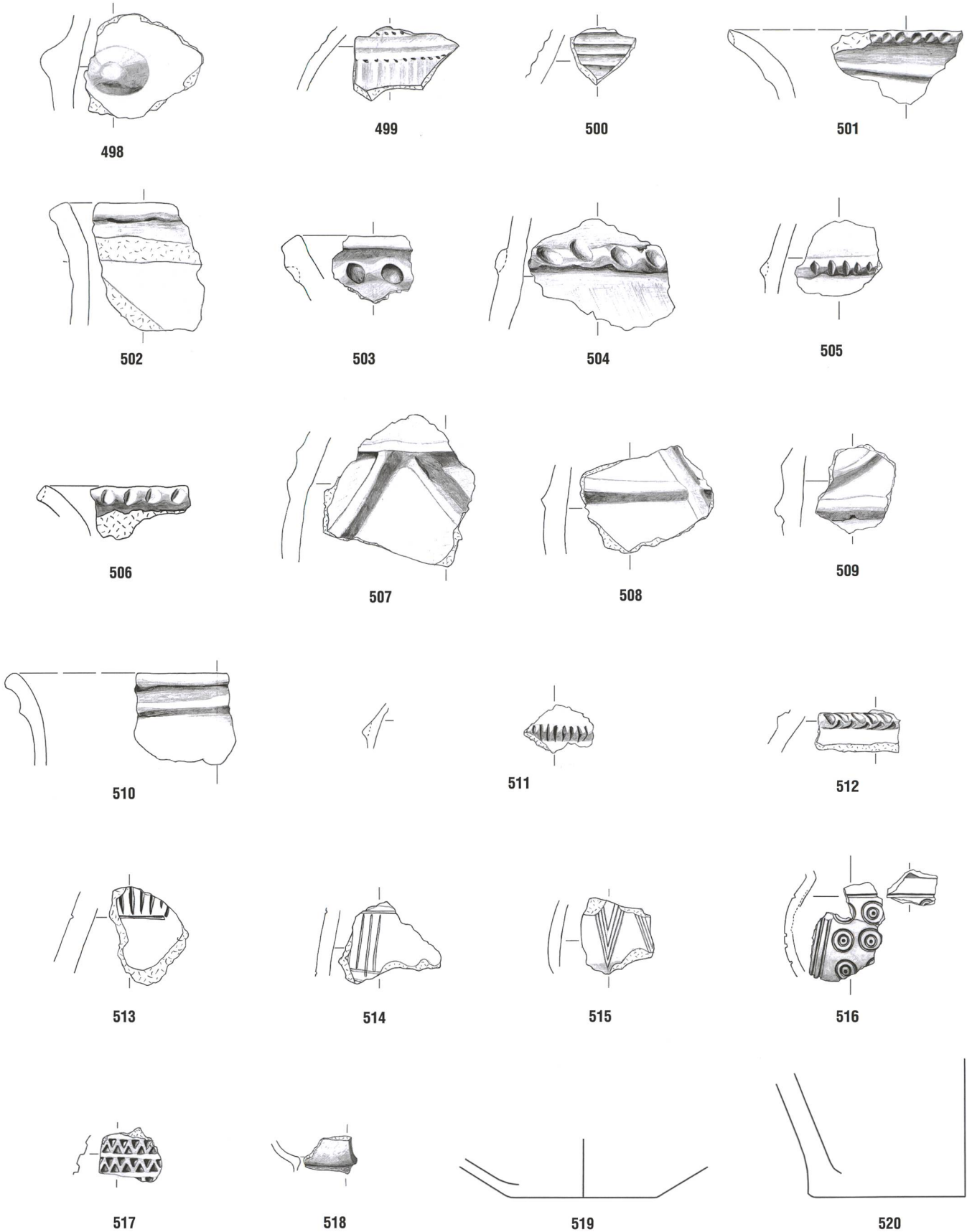

Tafel 41: Cazis, Cresta 1947–1970. Nördliche Zentralspalte, Keramikhorizont KH IV. Aus dem gestörten Bereich der Felder 17 und 18. 498–499, 501: Planum 11N. 500, 502–520: Plana 10N–11N. Keramik. Mst. 1:3.

521–527

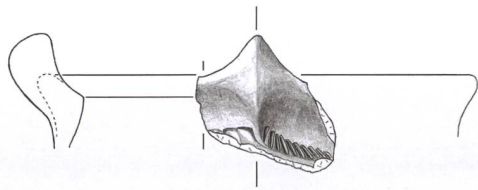

521

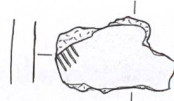

522

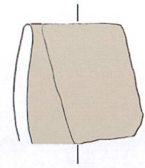

523

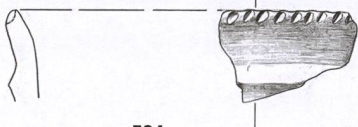

524



525

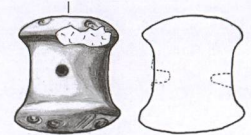

526

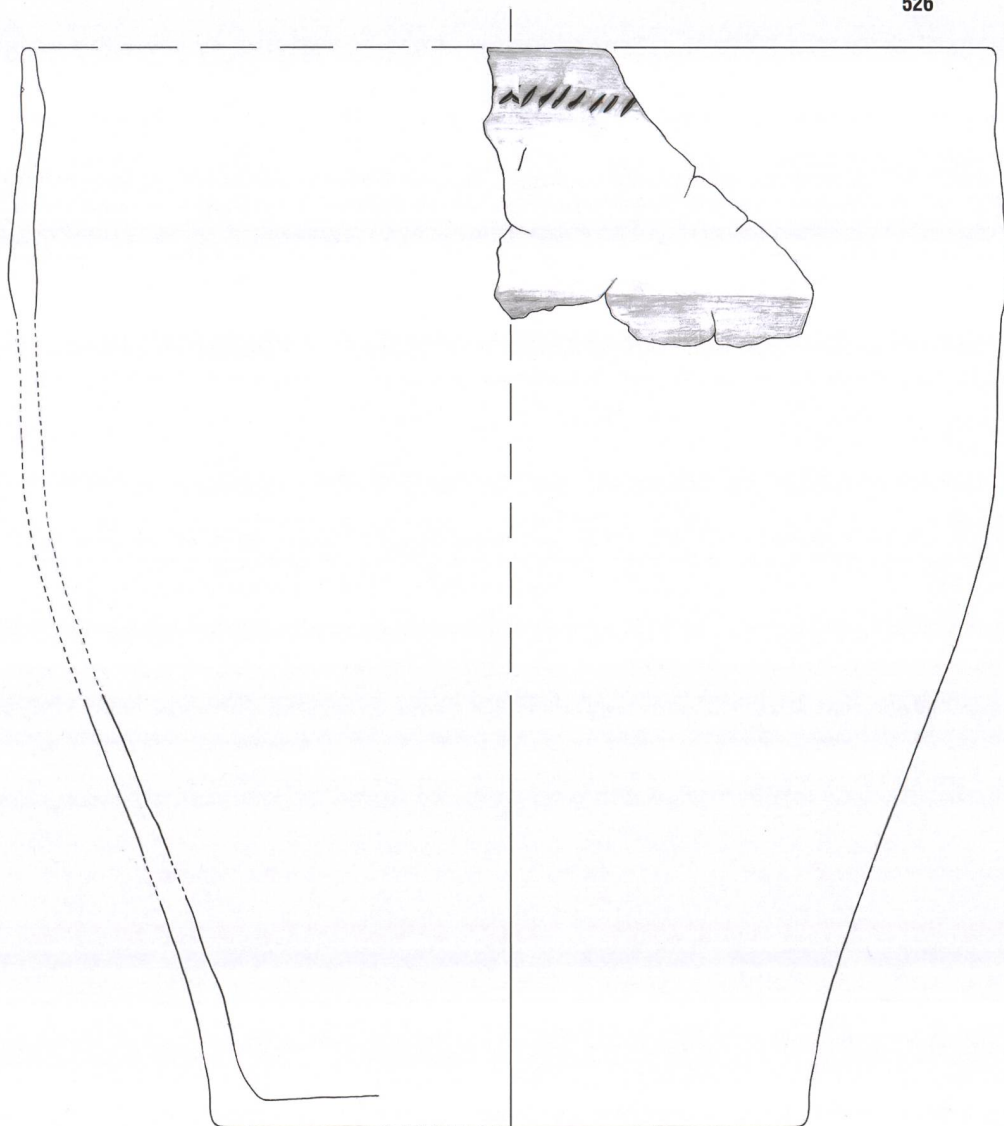

527

Tafel 42: Cazis, Cresta 1947–1970. Nördliche Zentralspalte, Keramikhorizont KH IV. Aus dem gestörten Bereich der Felder 17 und 18. 521–522, 525–527: Planum 14N. 523–524: Plana 10N–14N. Keramik. Mst. 1:3.

528-537

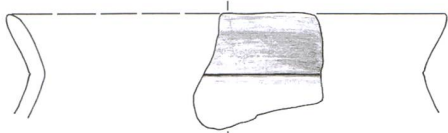

528



531



534



529



532

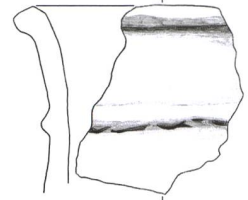

535



530



533

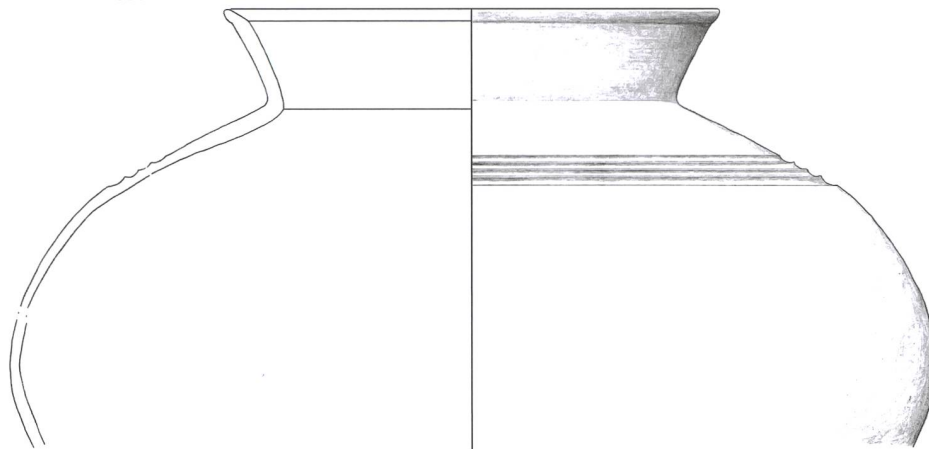

536

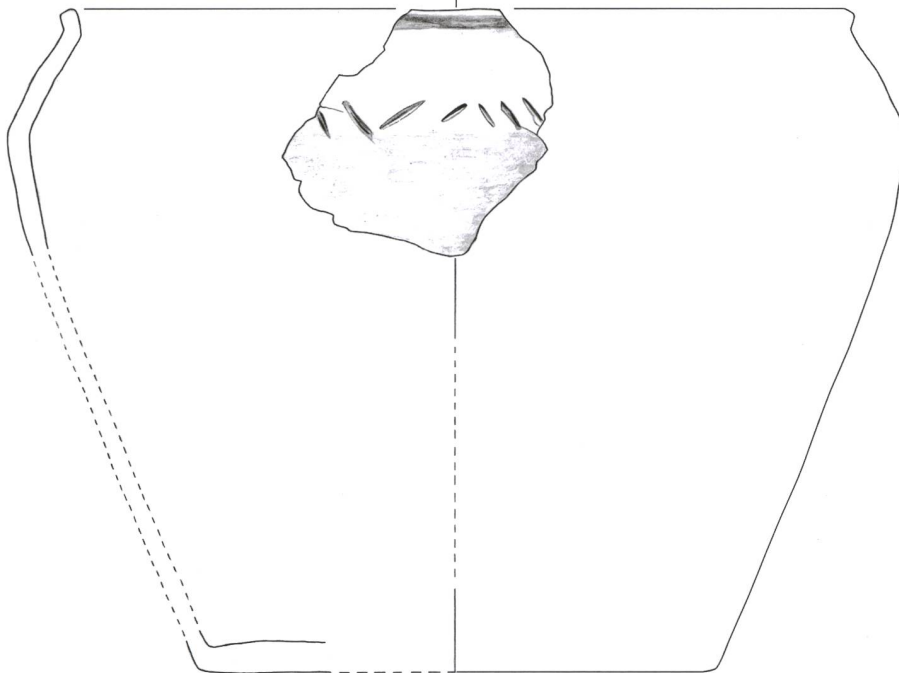

537

Tafel 43: Cazis, Cresta 1947-1970. Nördliche Zentralspalte, Keramikhorizont KH IV. Aus dem gestörten Bereich der Felder 17 und 18. 528-537: Planum 15N. Keramik. Mst. 1:3.

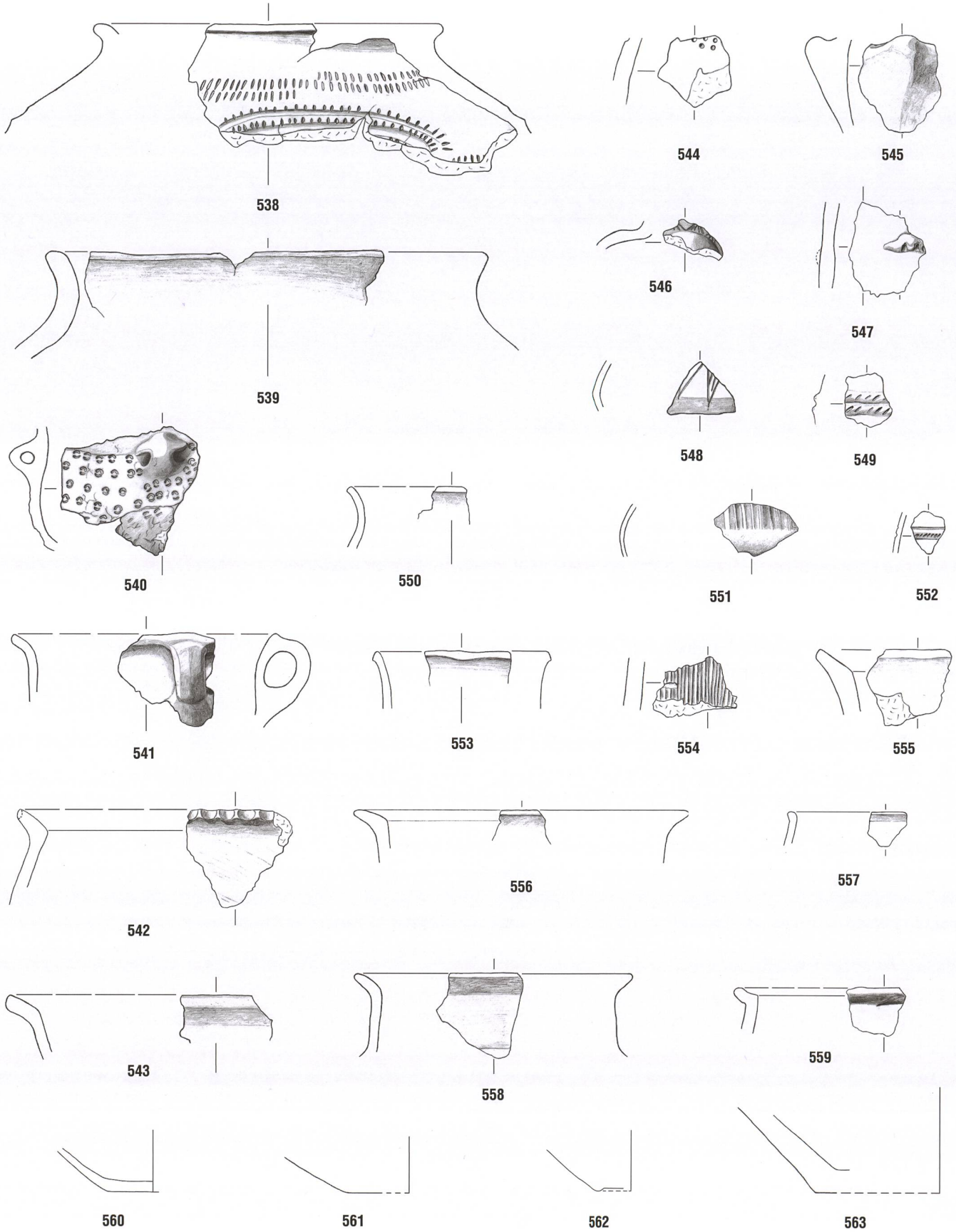

Tafel 44: Cazis, Cresta 1947-1970. Nördliche Zentralspalte, Keramikhorizont KH IV. 538-563: Planum 14N. Keramik. Mst. 1:3.

564–574

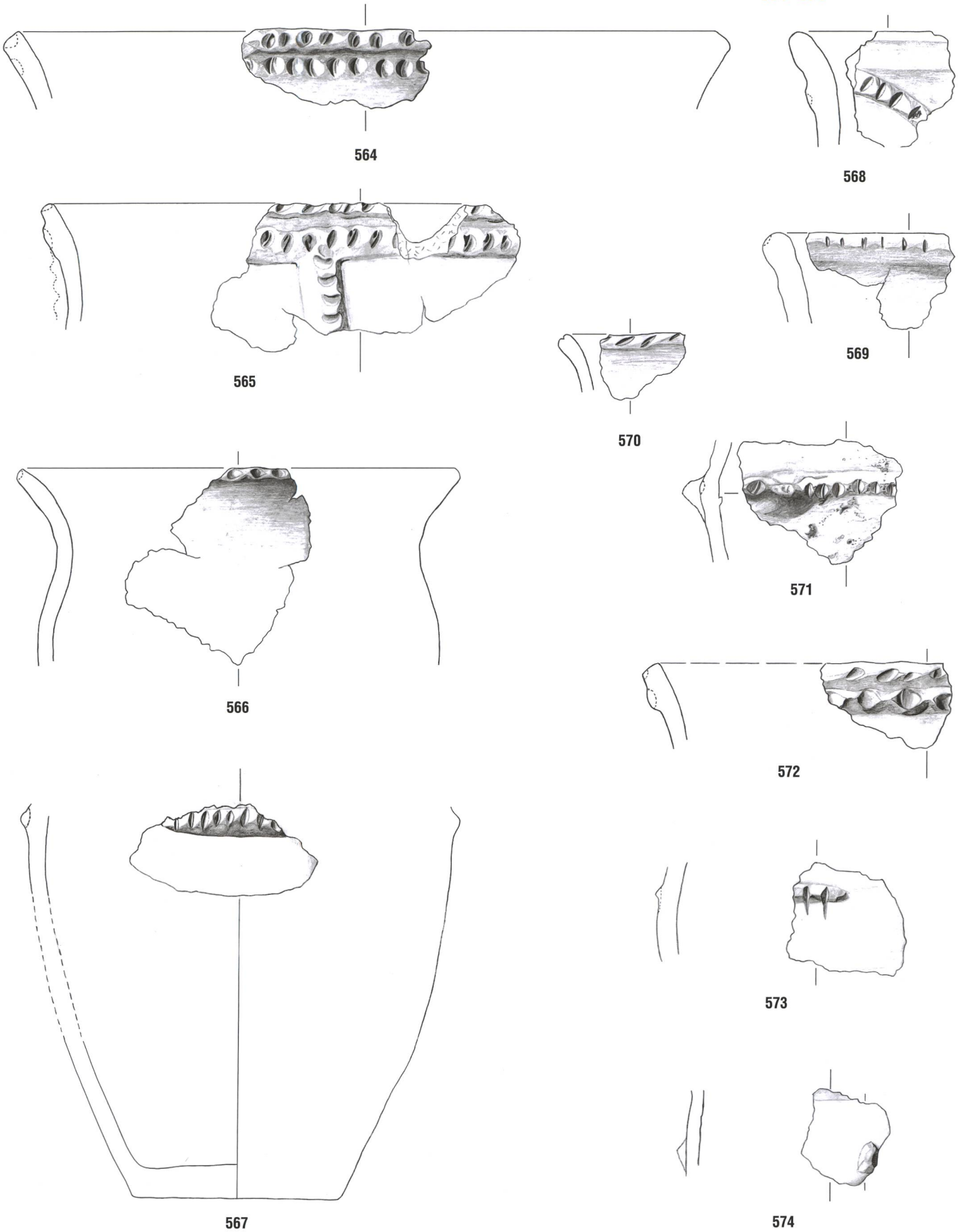

Tafel 45: Cazis, Cresta 1947–1970. Nördliche Zentralspalte, Keramikhorizont KH IV. 564–565, 567–570, 572, 574: Planum 14N. 566, 571, 573: Plana 12N–14N. Keramik. Mst. 1:3.

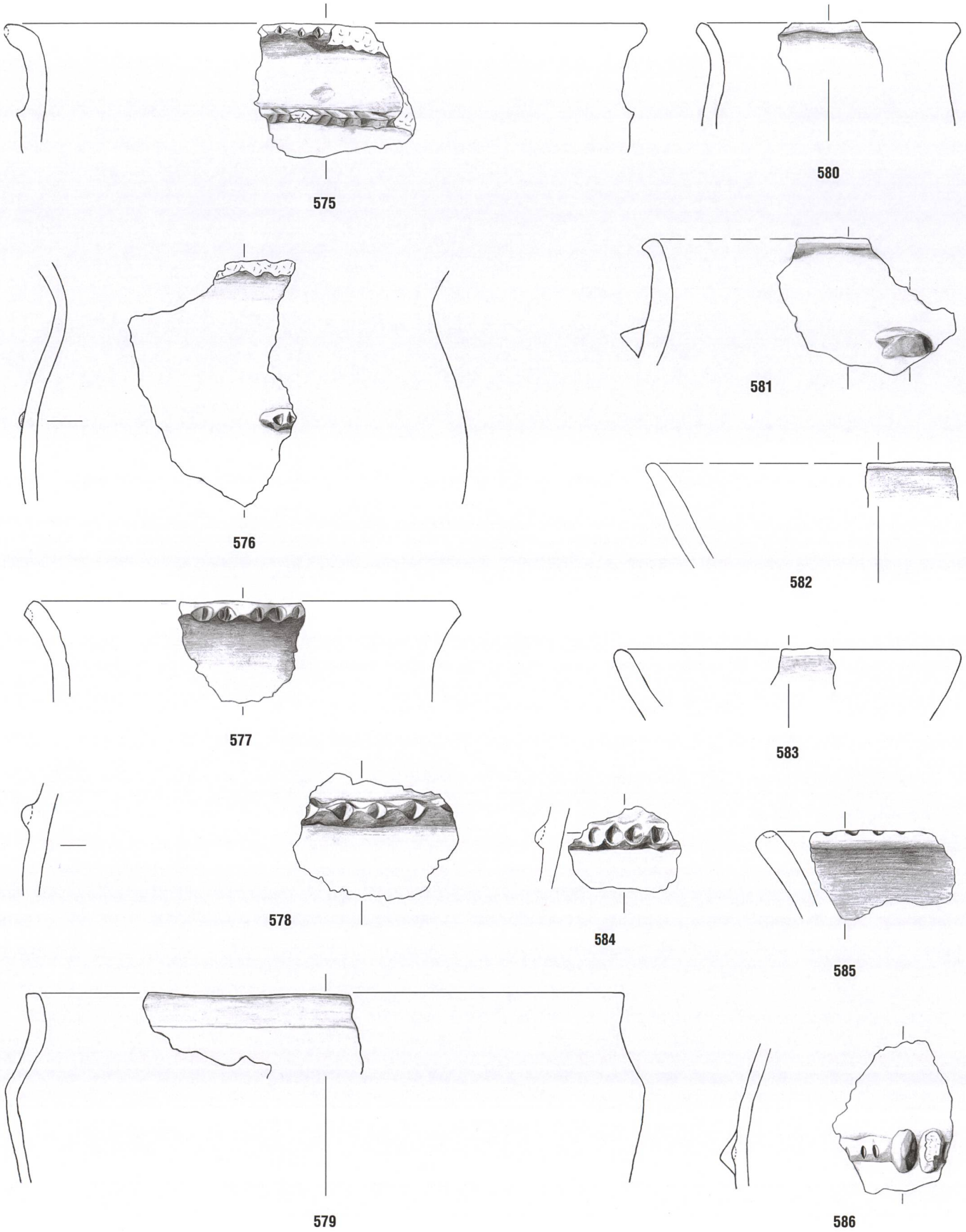

Tafel 46: Cazis, Cresta 1947-1970. Nördliche Zentralspalte, Keramikhorizont KH IV. 575-583: Planum 14N. 584-586: Planum 15N. Keramik. Mst. 1:3.

587-613

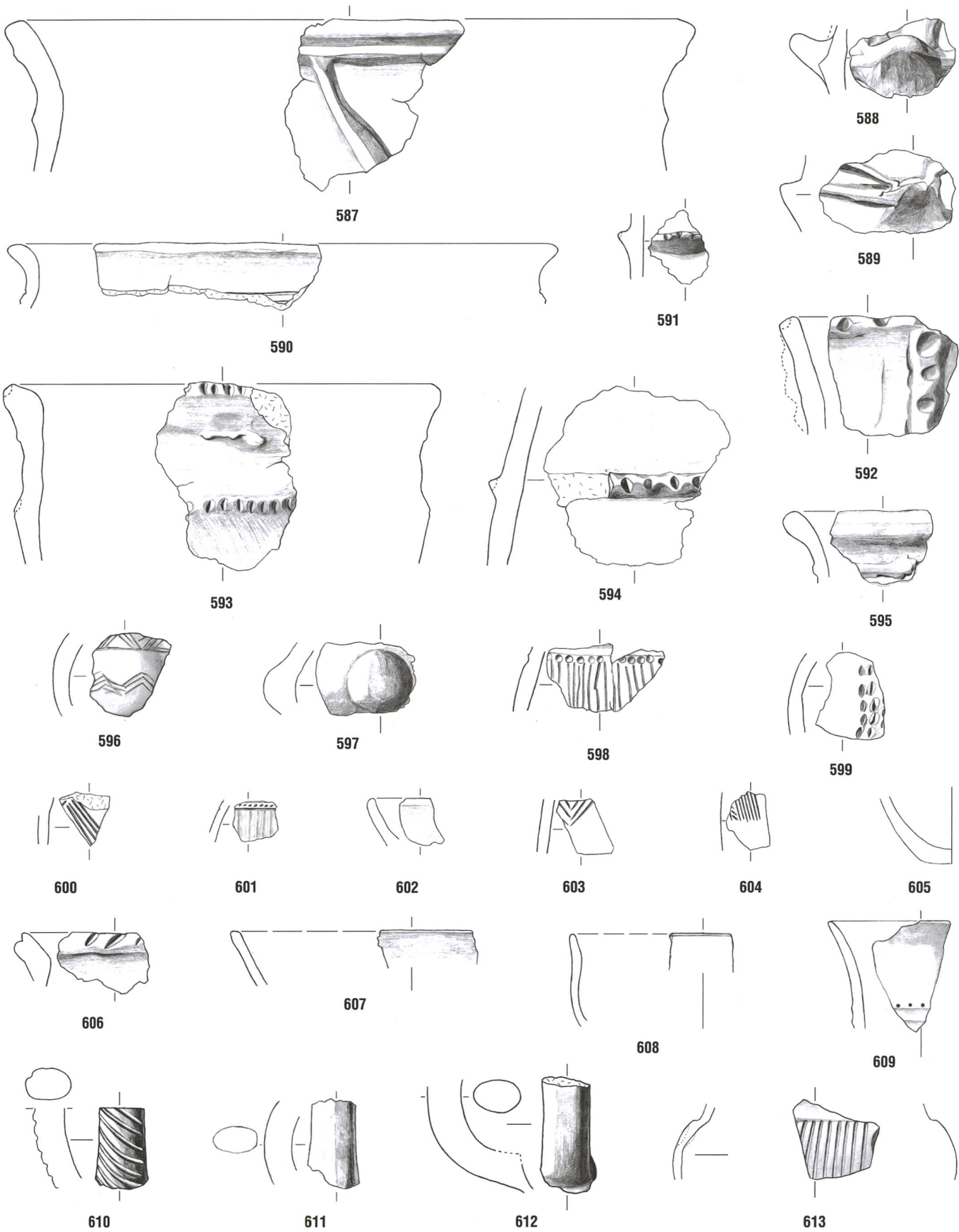

Tafel 47: Cazis, Cresta 1947-1970. Nördliche Zentralspalte, Keramikhorizont KH IV. 587-609, 617-613: Planum 15N. 610: Planum 14S oder 15S. Keramik. Mst. 1:3.

614-634

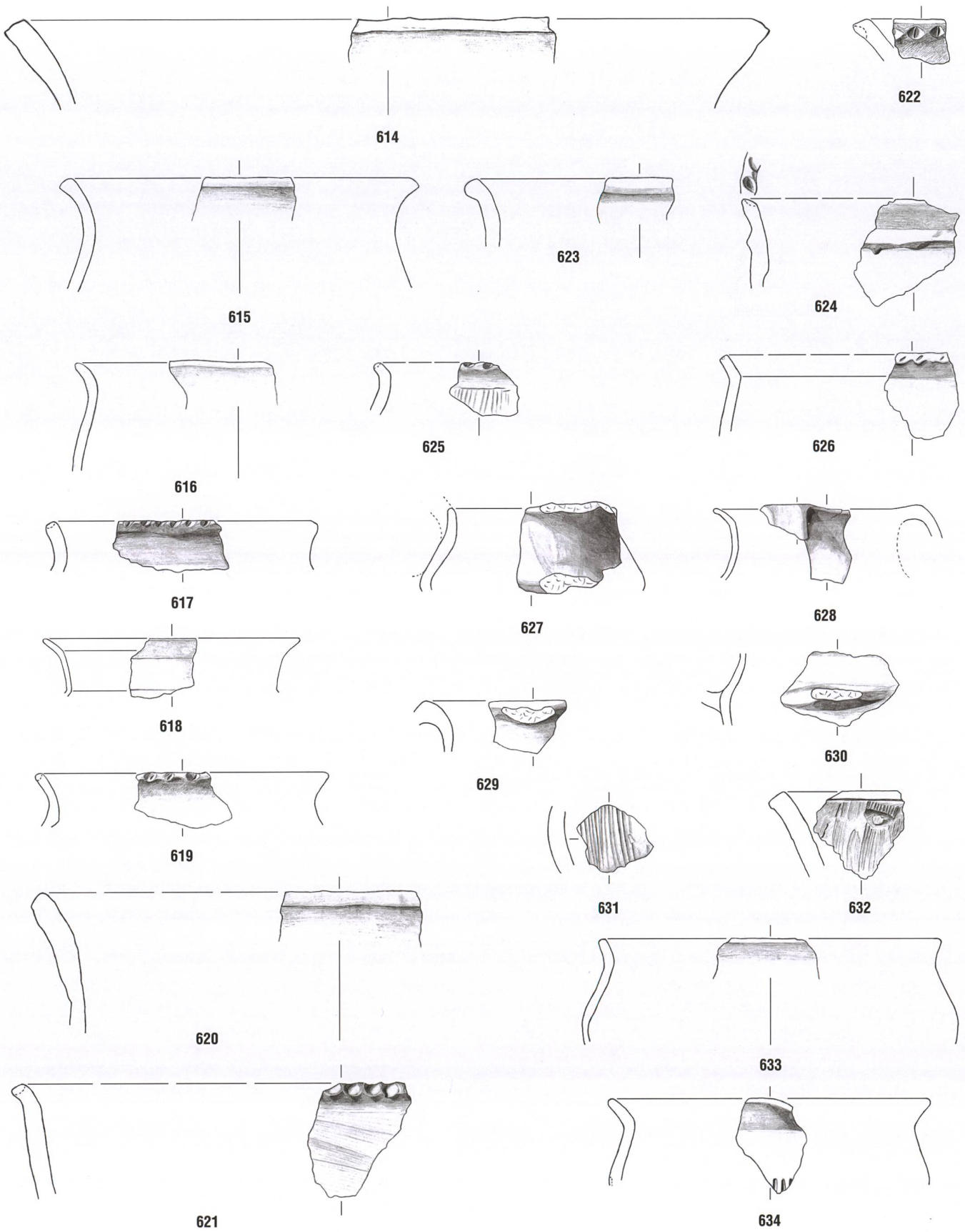

Tafel 48: Casis, Cresta 1947-1970. Nördliche Zentralspalte, Keramikhorizont KH IV. 614-634: Planum 15N. Keramik. Mst. 1:3.

635-660

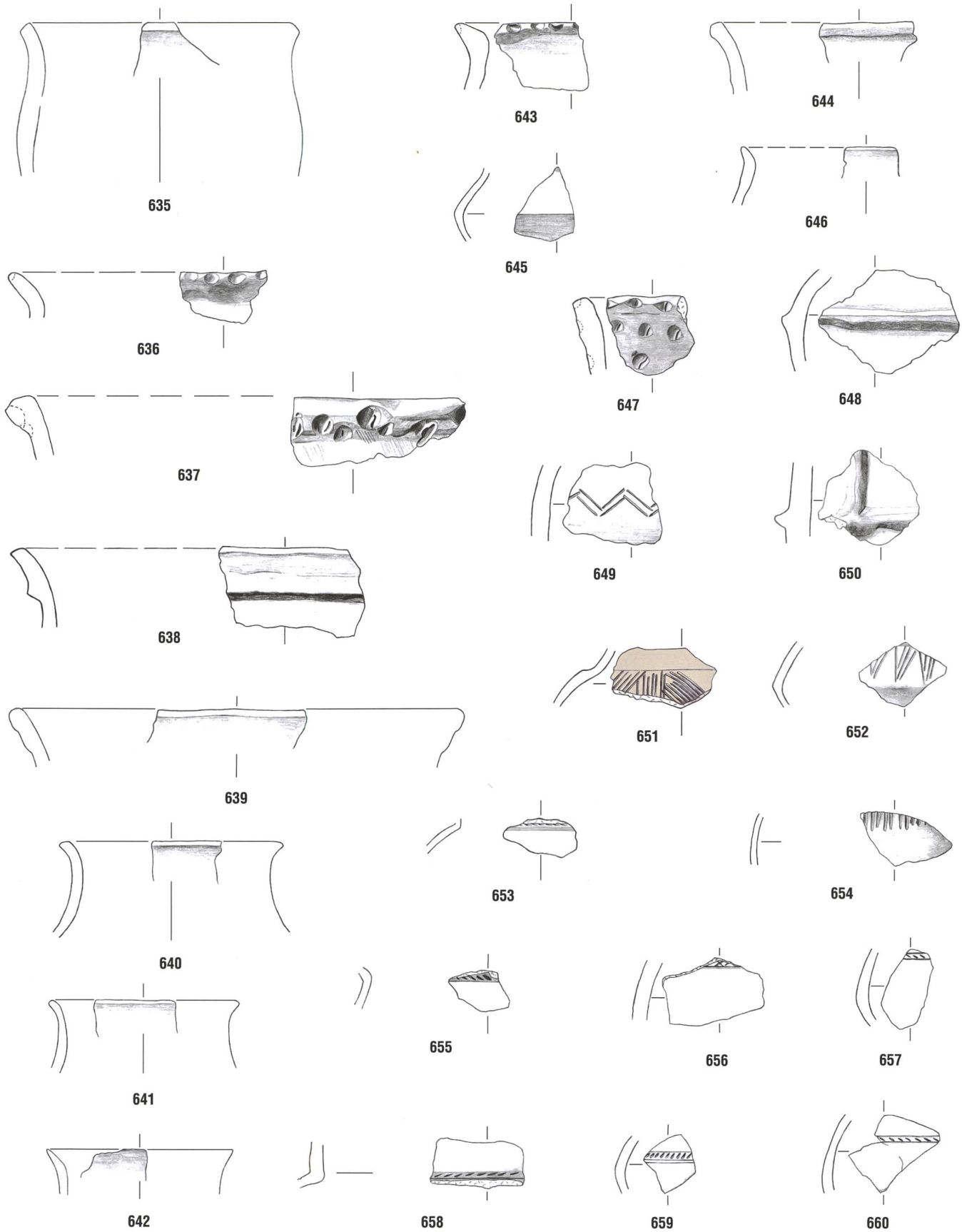

Tafel 49: Cazis, Cresta 1947-1970. Nördliche Zentralspalte, Keramikhorizont KH IV. 635-636, 638-643, 648-660: Planum 16N. 637, 647: Plana 15N-16N. 644, 646: Planum 17N. 645: Plana 15N-17N. Keramik. Mst. 1:3.

661-686

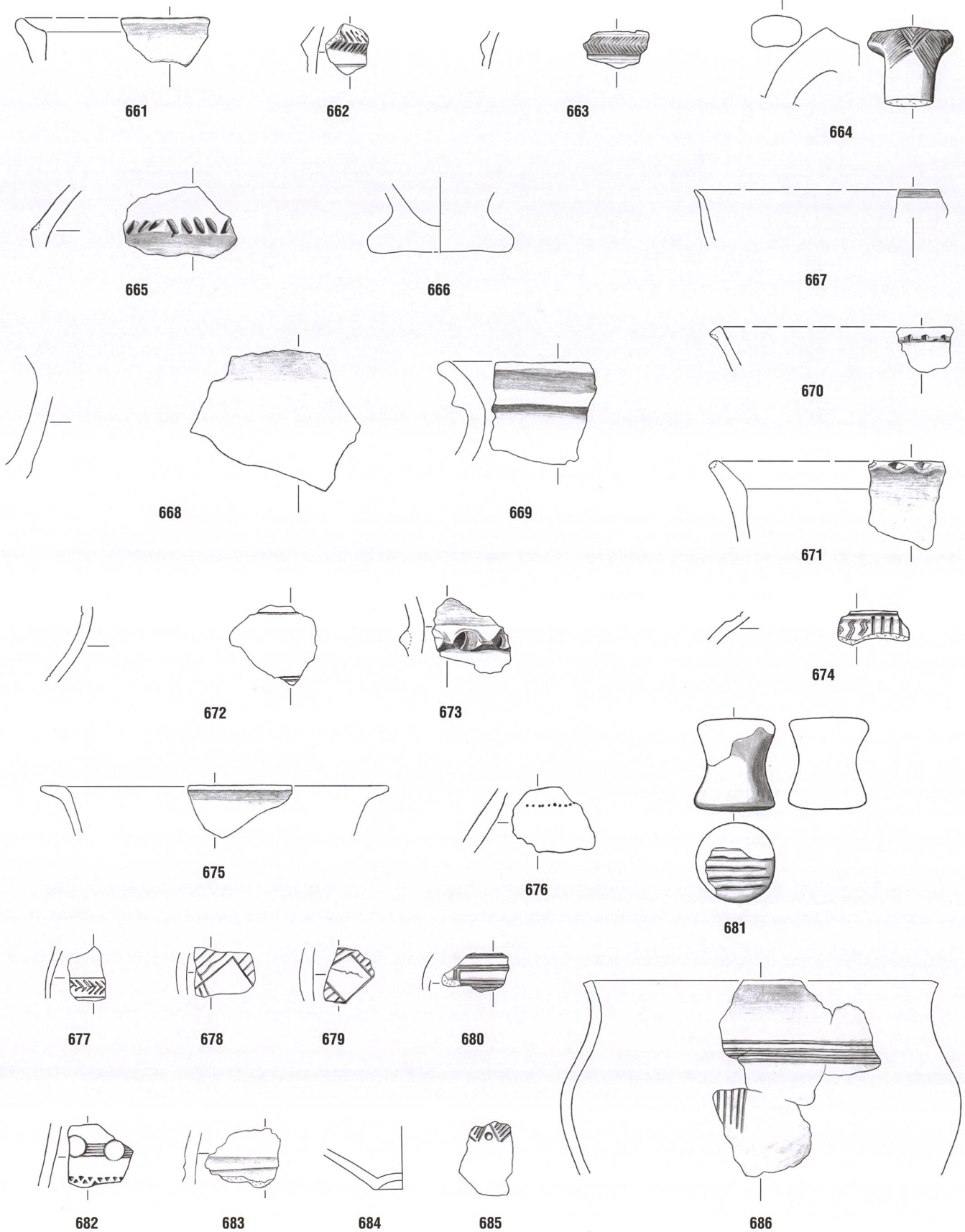

Tafel 50: Cazis, Cresta 1947-1970. Nördliche Zentralspalte, Keramikhorizont KH IV. 661-664, 666-667, 671: Planum 16N. 665: Plana 15N-16N. 668-671: Plana 15N-17N. 672-686: Planum 17N. Keramik. Mst. 1:3.

687-694

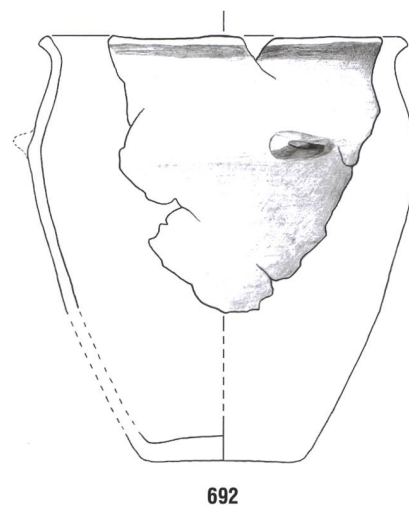
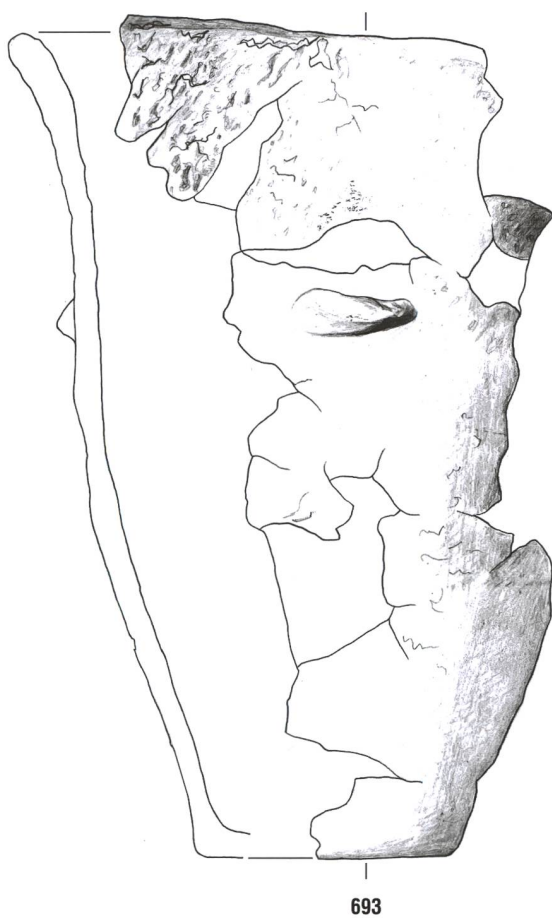
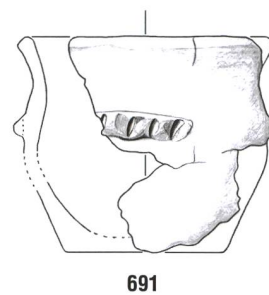
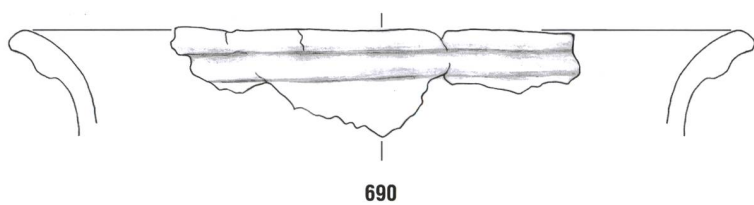
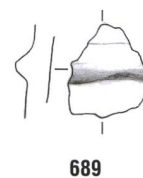
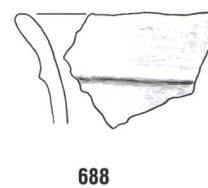
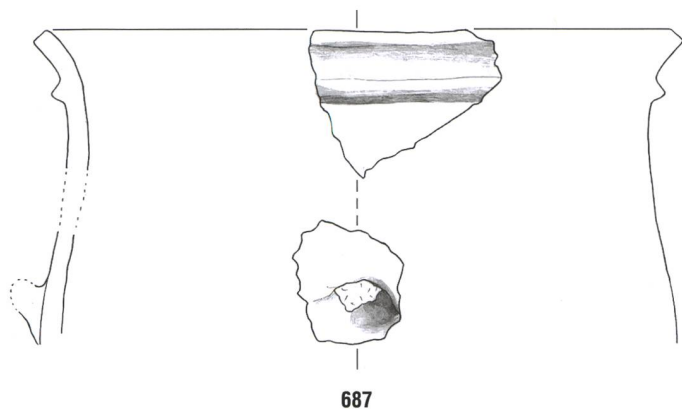

Tafel 51: Cazis, Cresta 1947-1970. Südliche Zentralspalte, Keramikhorizont KH I. 687: Planum 4S. 688: Plana 1S-3S. 689-690: Planum 5S. 691: Planum 3S. Keramikhorizont KH II: 692-694: Planum 6S. Keramik. Mst. 1:3.

695-704

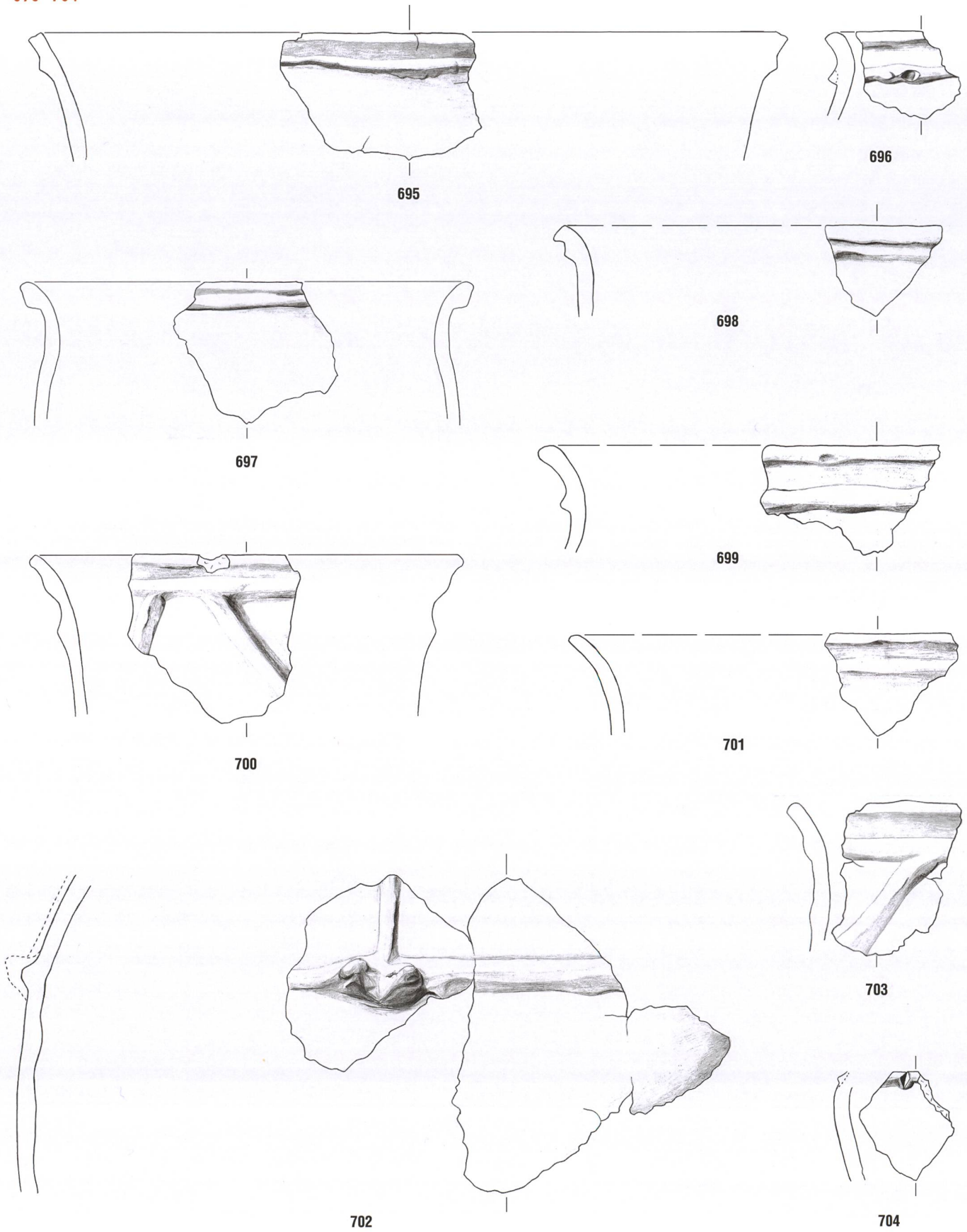

Tafel 52: Cazis, Cresta 1947-1970. Südliche Zentralspalte, Keramikhorizont KH II. 695-704: Planum 6S. Keramik. Mst. 1:3.

705-714

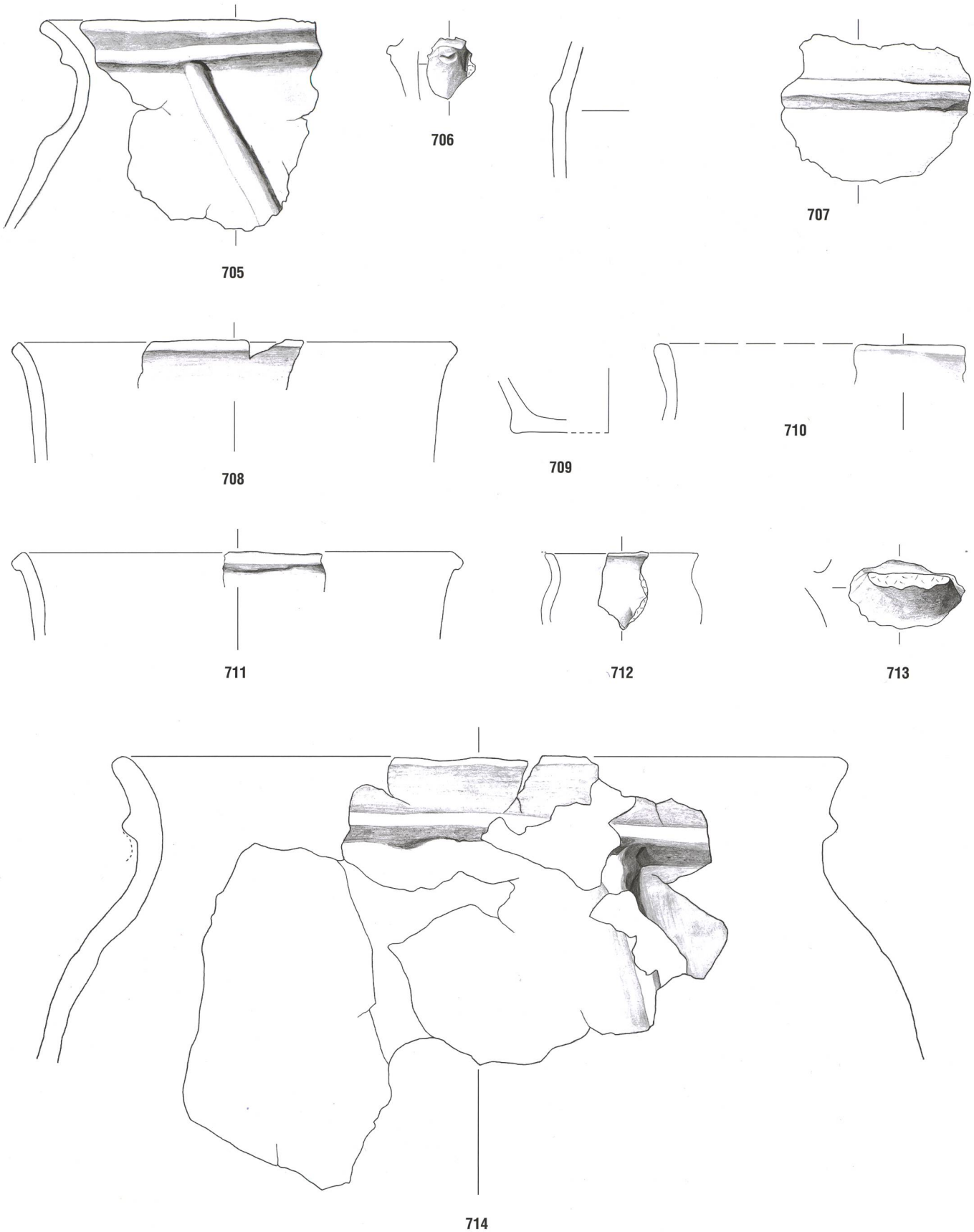

Tafel 53: Cazis, Cresta 1947-1970. Südliche Zentralspalte, Keramikhorizont KH II. 705-713: Planum 6S. 714: Planum 7S. Keramik. Mst. 1:3.

715-729

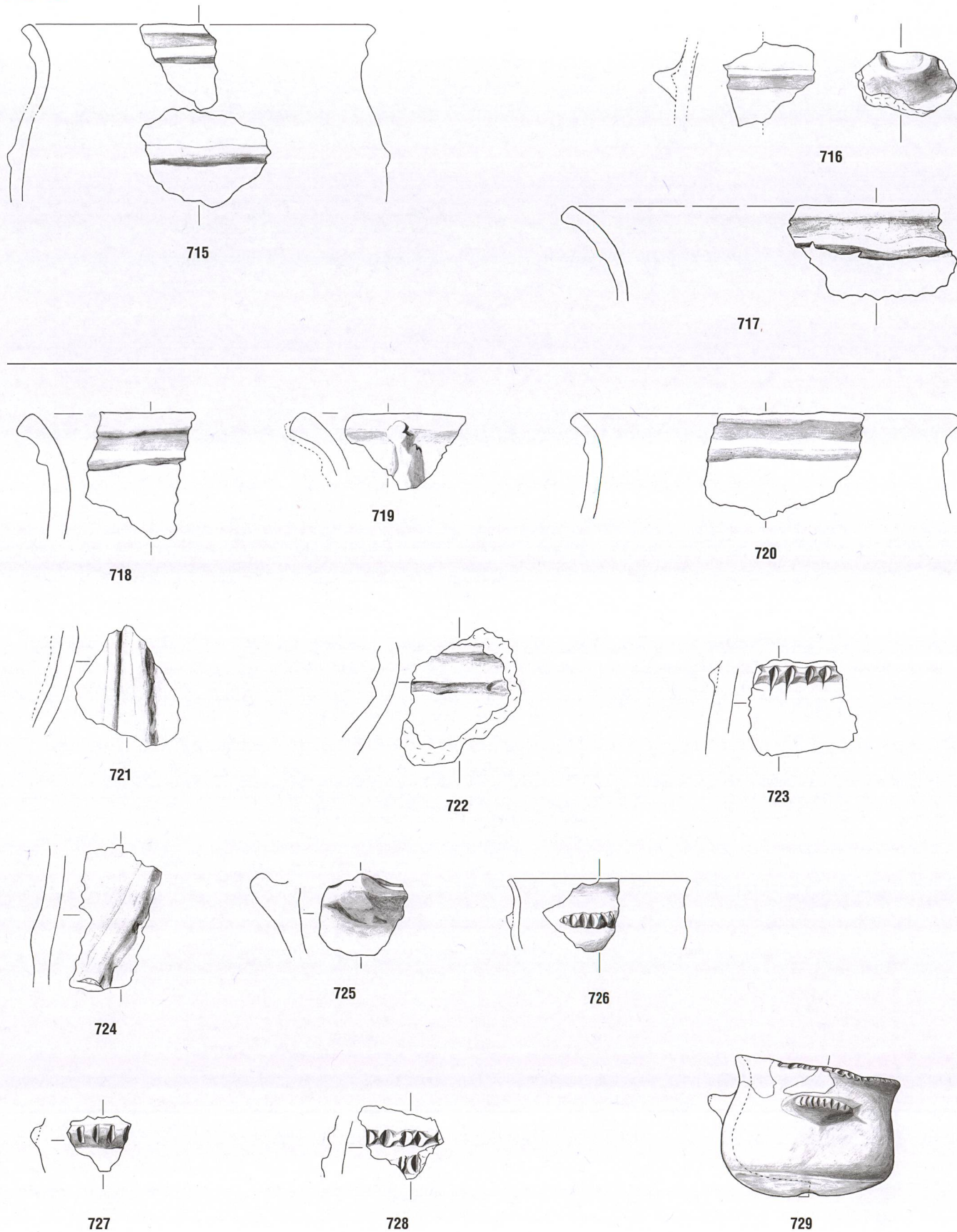

Tafel 54: Cazis, Cresta 1947-1970. Südliche Zentralspalte, Keramikhorizont KH II. 715-717: Planum 7S. Keramikhorizont KH III. 718-729: Planum 8S. Keramik. Mst. 1:3.



730-737

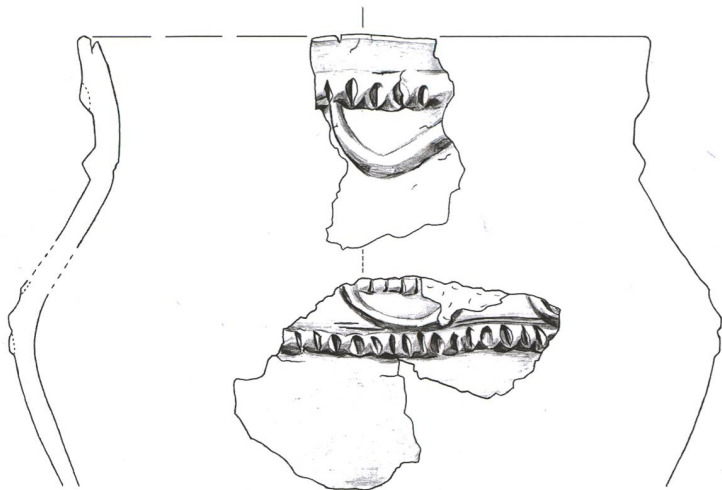

730

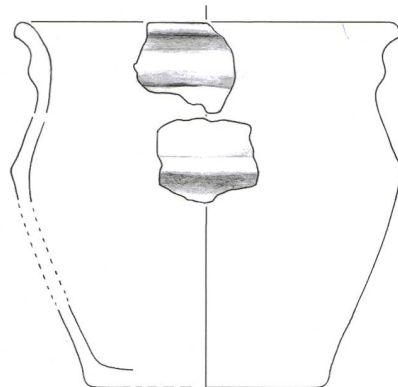

731

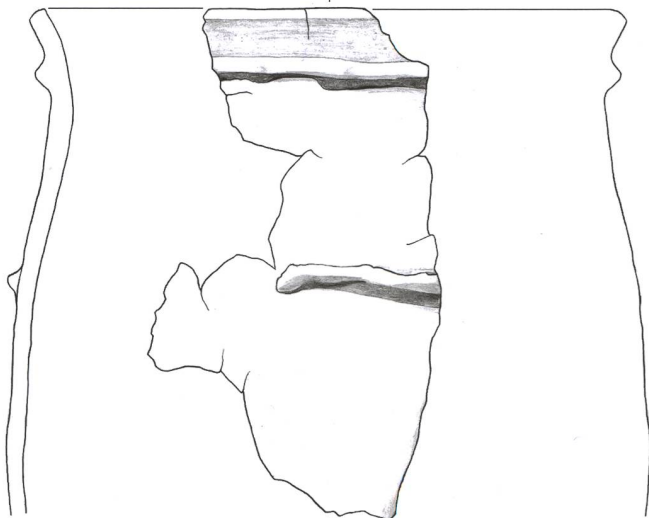

734

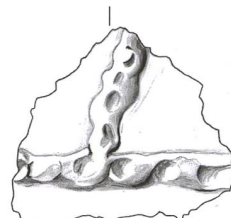

732

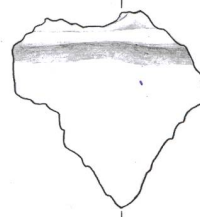

733



735

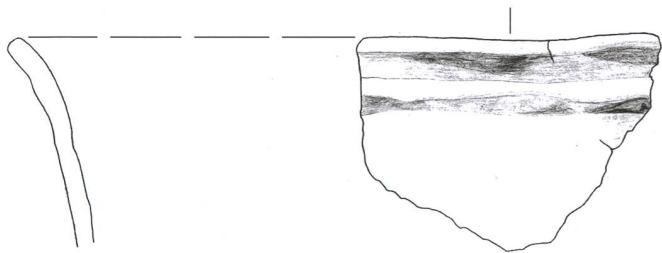

736

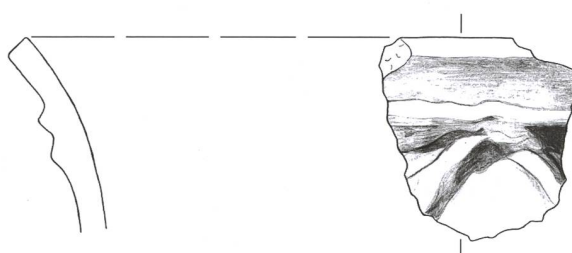

737

Tafel 55: Cazis, Cresta 1947-1970. Südliche Zentralspalte, Keramikhorizont KH III. 730-737: Planum 8S. Keramik. Mst. 1:3.

738-750

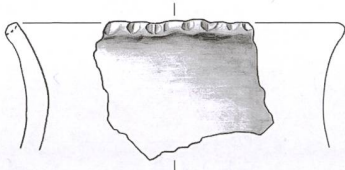

738

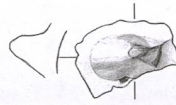

739

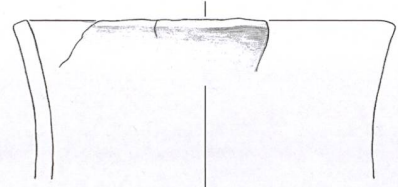

740

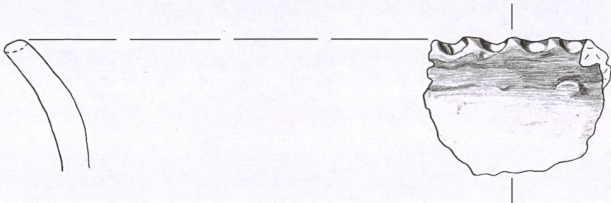

741

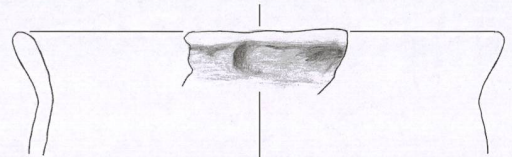

742

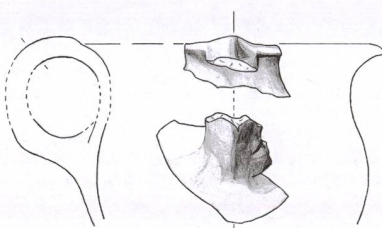

743

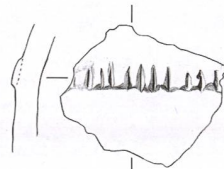

744



745



746

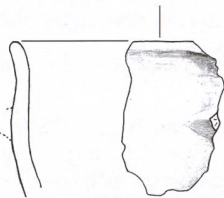

747

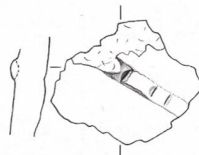

748

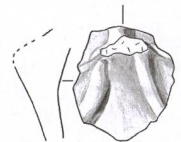

749

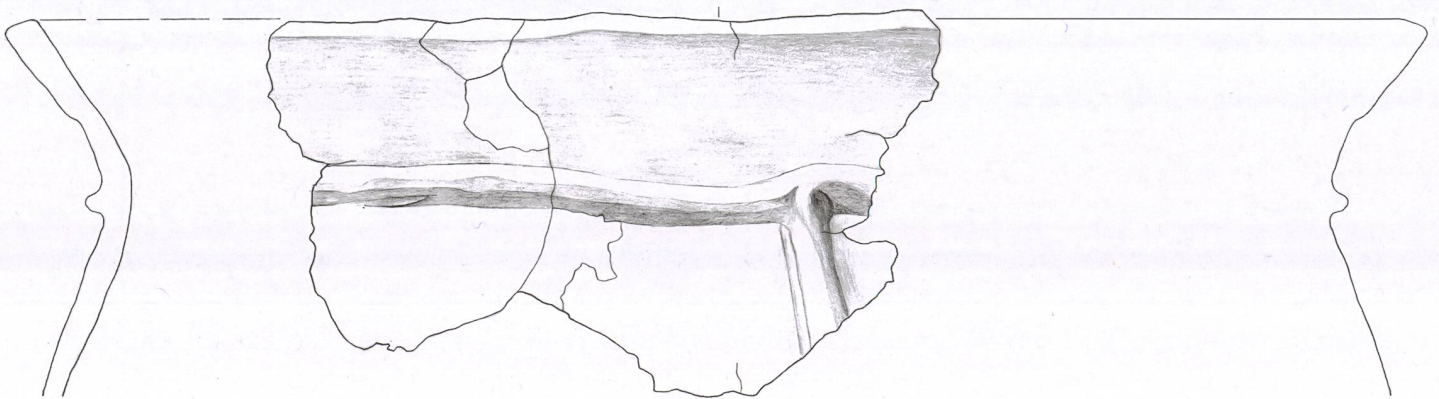

750

Tafel 56: Cazis, Cresta 1947-1970. Südliche Zentralspalte, Keramikhorizont KH III. 738-741, 743-748: Planum 8S. 742, 749: Plana 8S-9S. 750: Planum 9S. Keramik. Mst. 1:3.

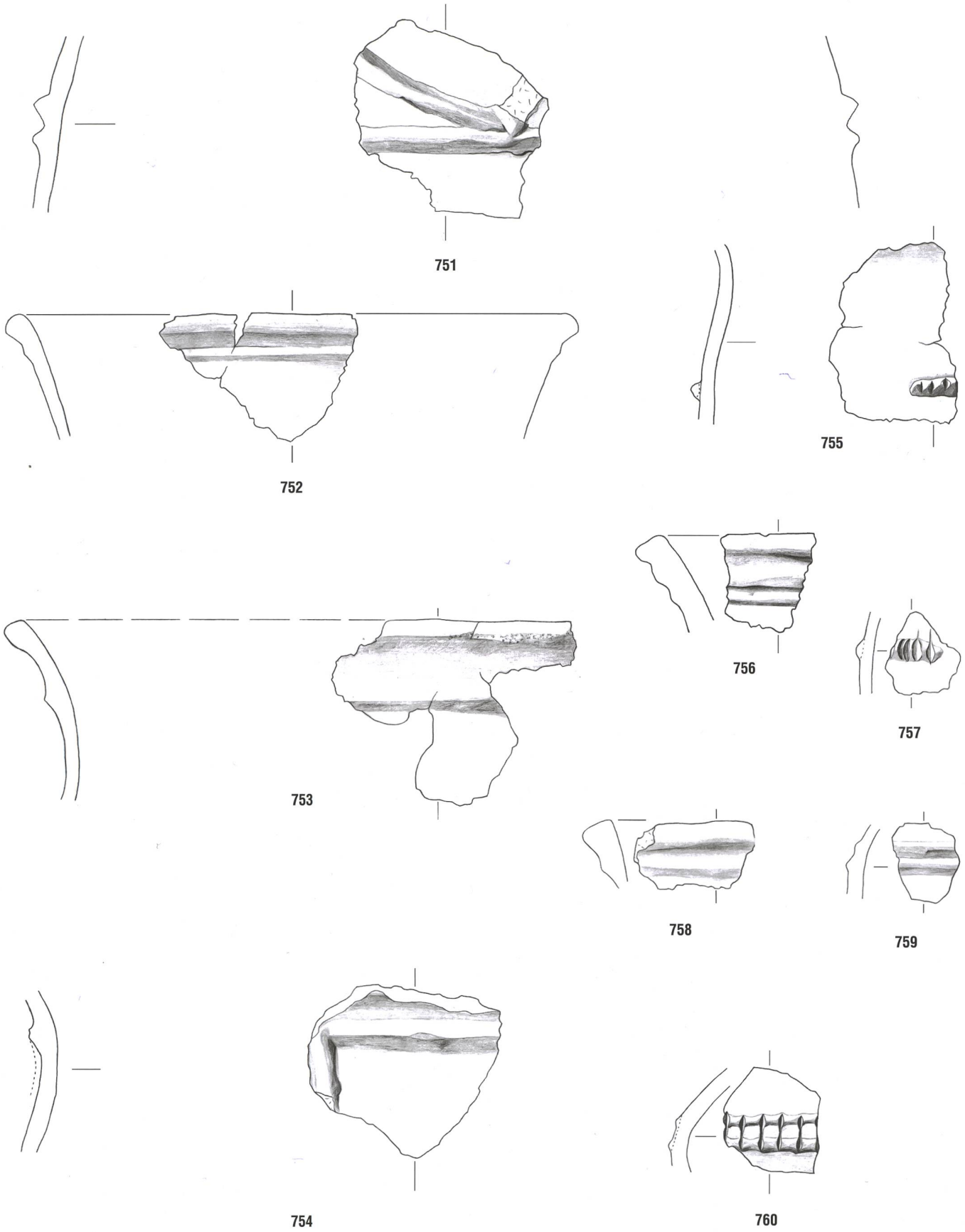

Tafel 57: Cazis, Cresta 1947-1970. Südliche Zentralspalte, Keramikhorizont KH III. 751-760: Planum 9S. Keramik. Mst. 1:3.

761-766

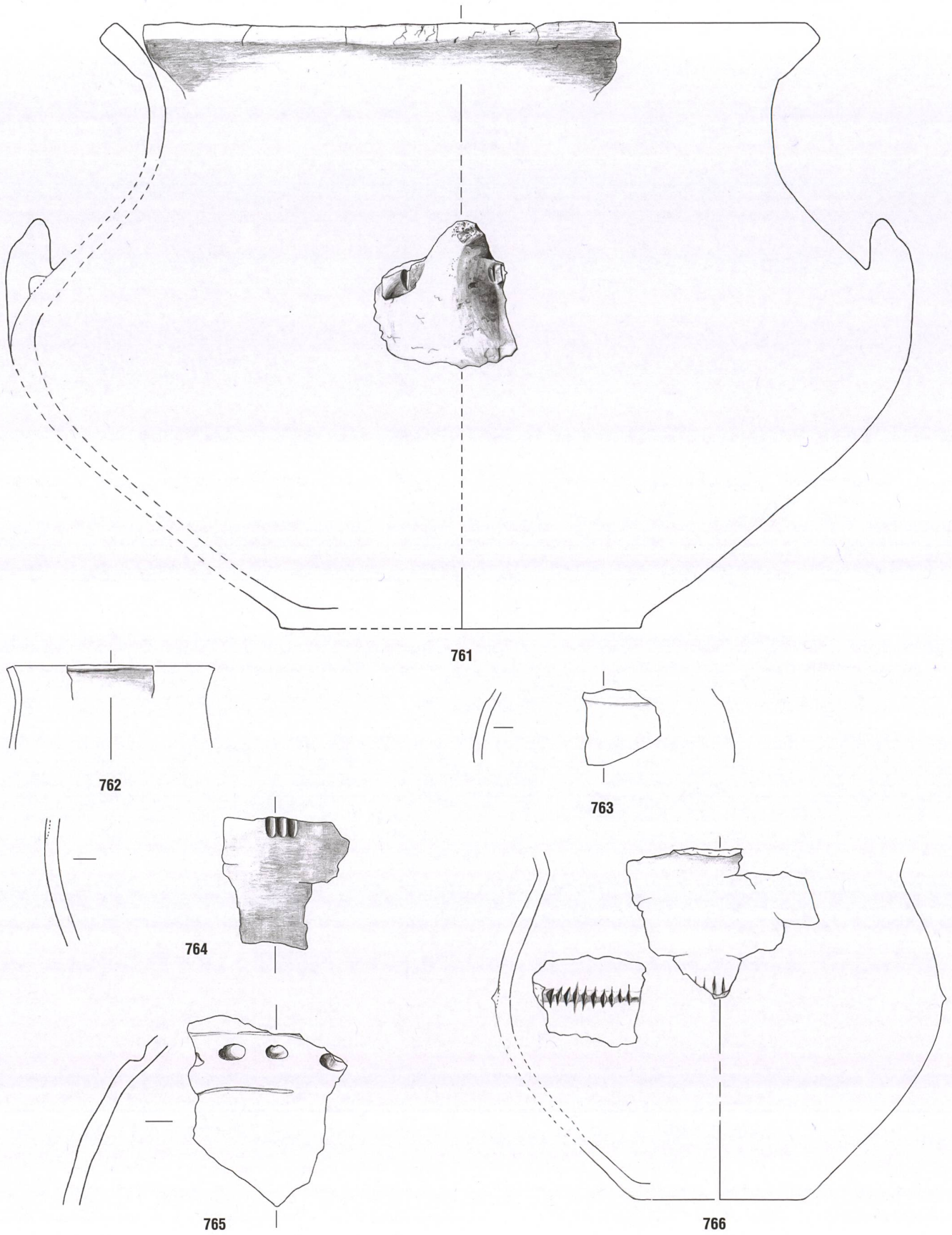

Tafel 58: Cazis, Cresta 1947-1970. Südliche Zentralspalte, Keramikhorizont KH III. 761-766: Planum 9S. Keramik. Mst. 1:3.



767-775

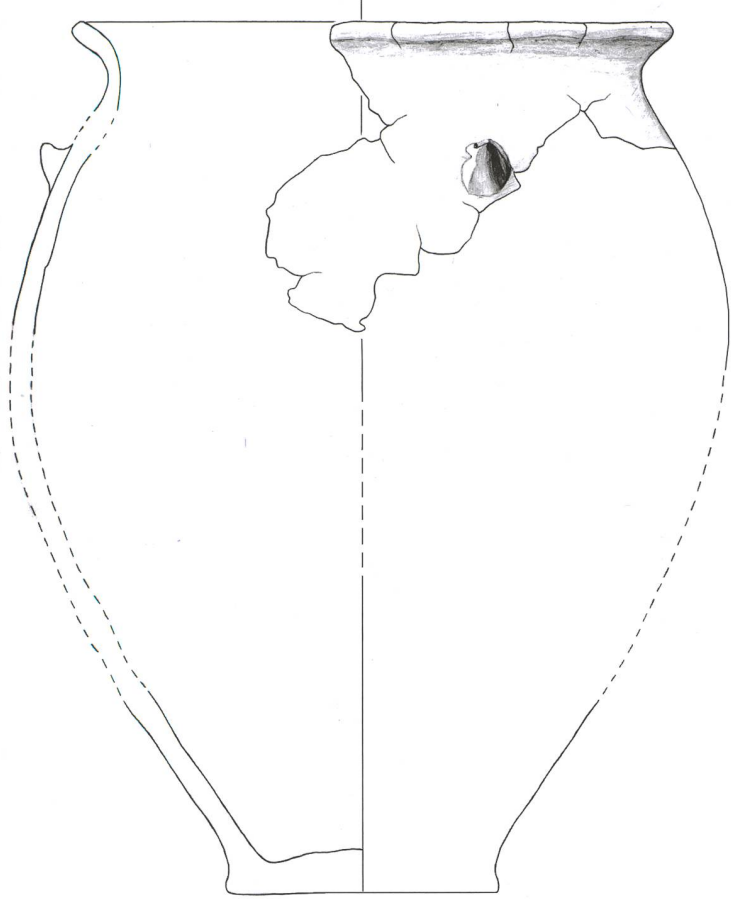

767

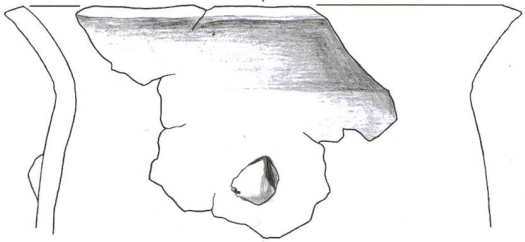

769

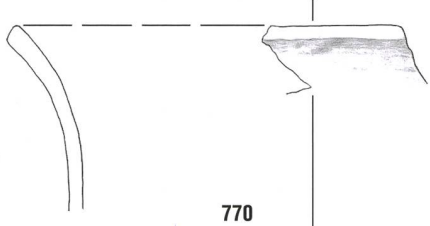

770



771

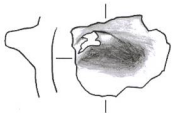

772

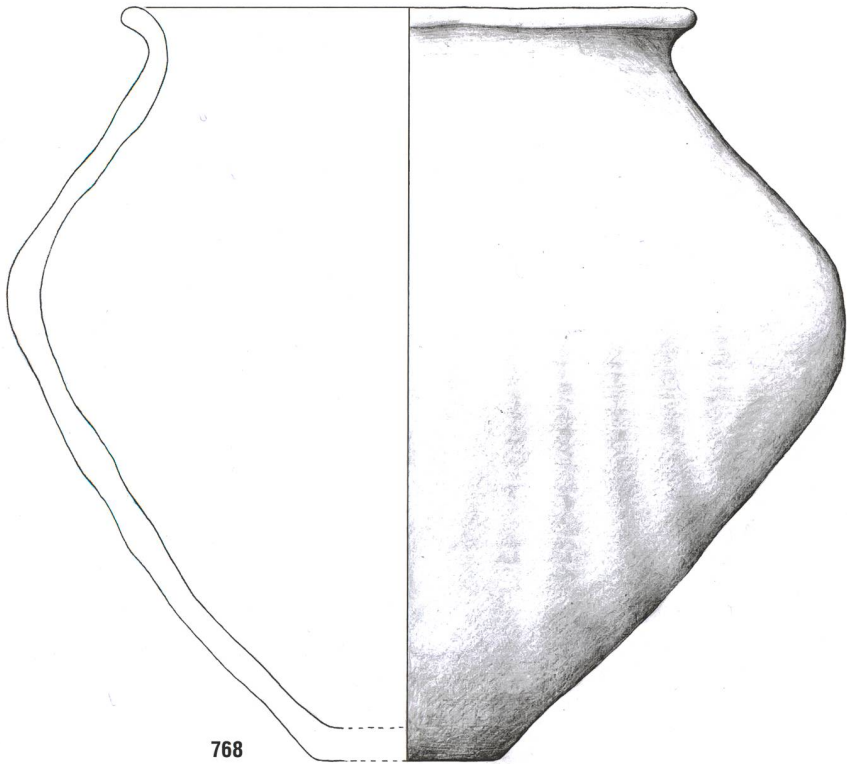

768

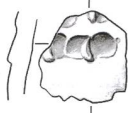

773

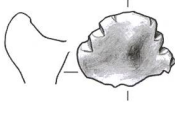

774

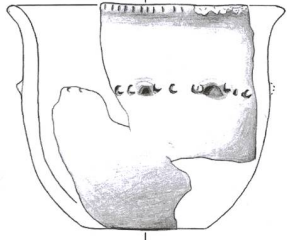

775

Tafel 59: Cazis, Cresta 1947-1970. Südliche Zentralspalte, Keramikhorizont KH III. 767-775: Planum 9S. Keramik. Mst. 1:3.

776-785

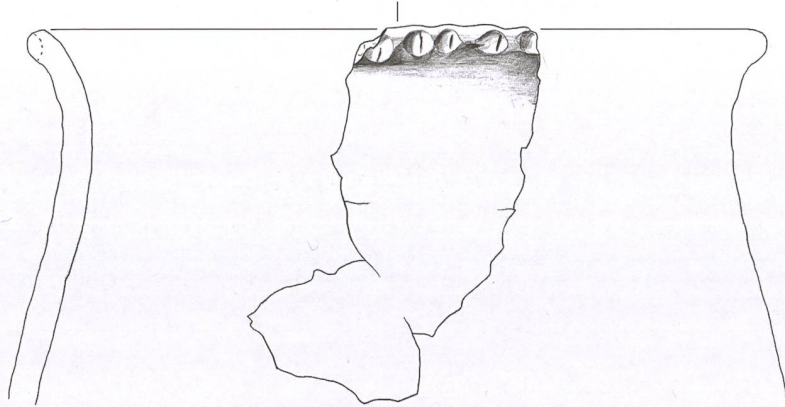

776

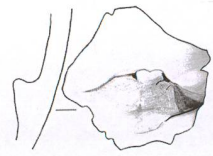

777



779

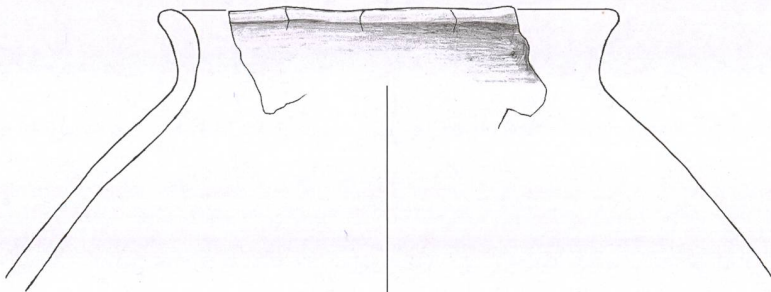

778

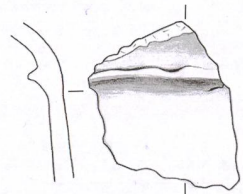

780

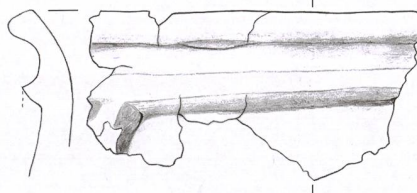

781

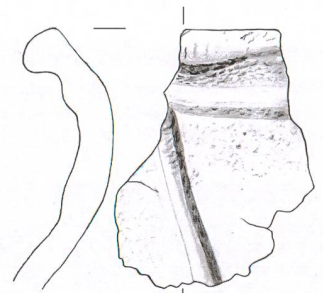

782

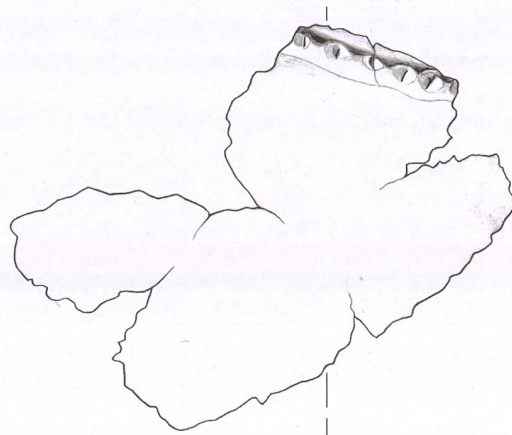

785

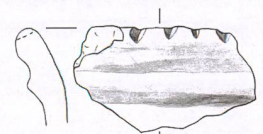

783

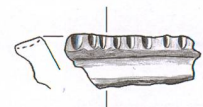

784

Tafel 60: Cazis, Cresta 1947-1970. Südliche Zentralspalte, Keramikhorizont KH III. 776-777, 779-780: Planum 9S. 778: Plana 8S-9S. 781-785: Planum 10S. Keramik. Mst. 1:3.

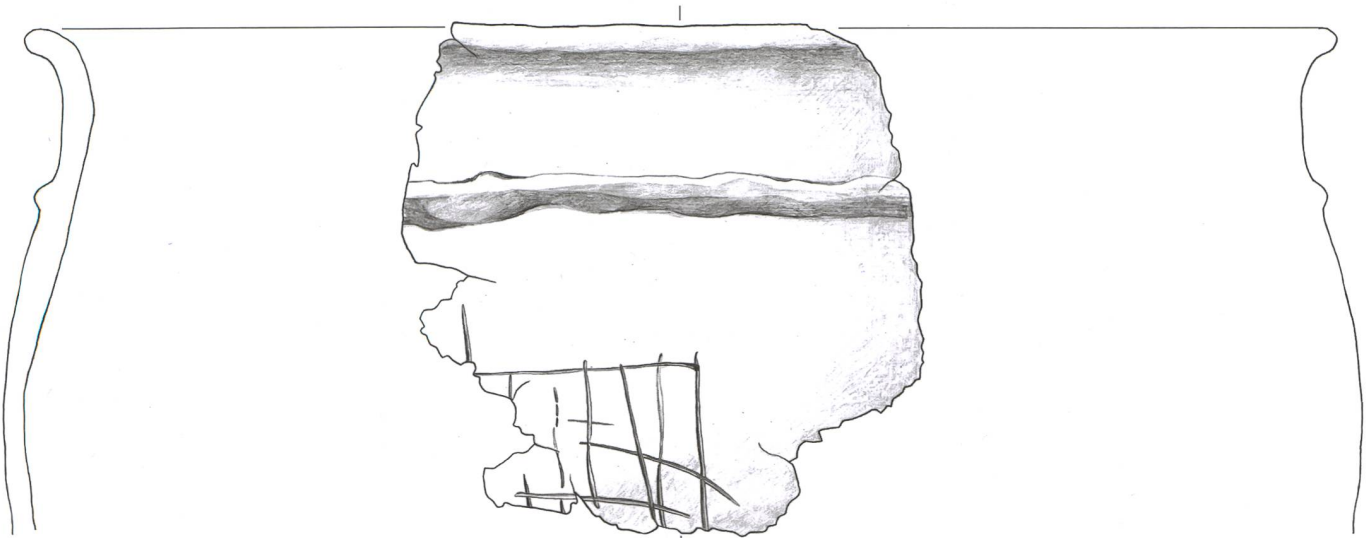

786

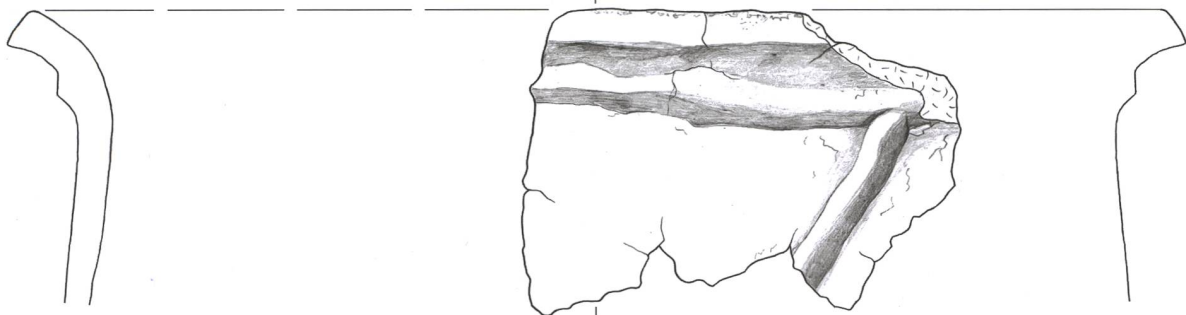

787

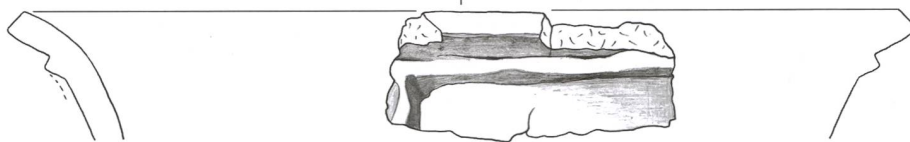

788

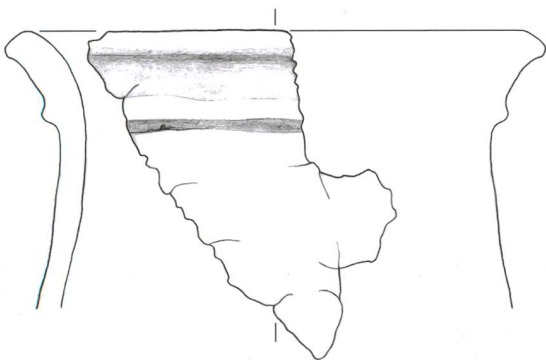

789

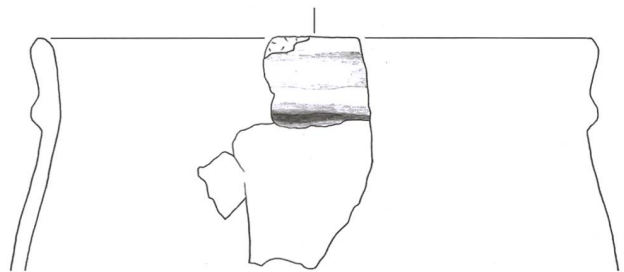

790

Tafel 61: Cazis, Cresta 1947-1970. Südliche Zentralspalte, Keramikhorizont KH III. 786-790: Planum 10S. Keramik. Mst. 1:3.

791-799

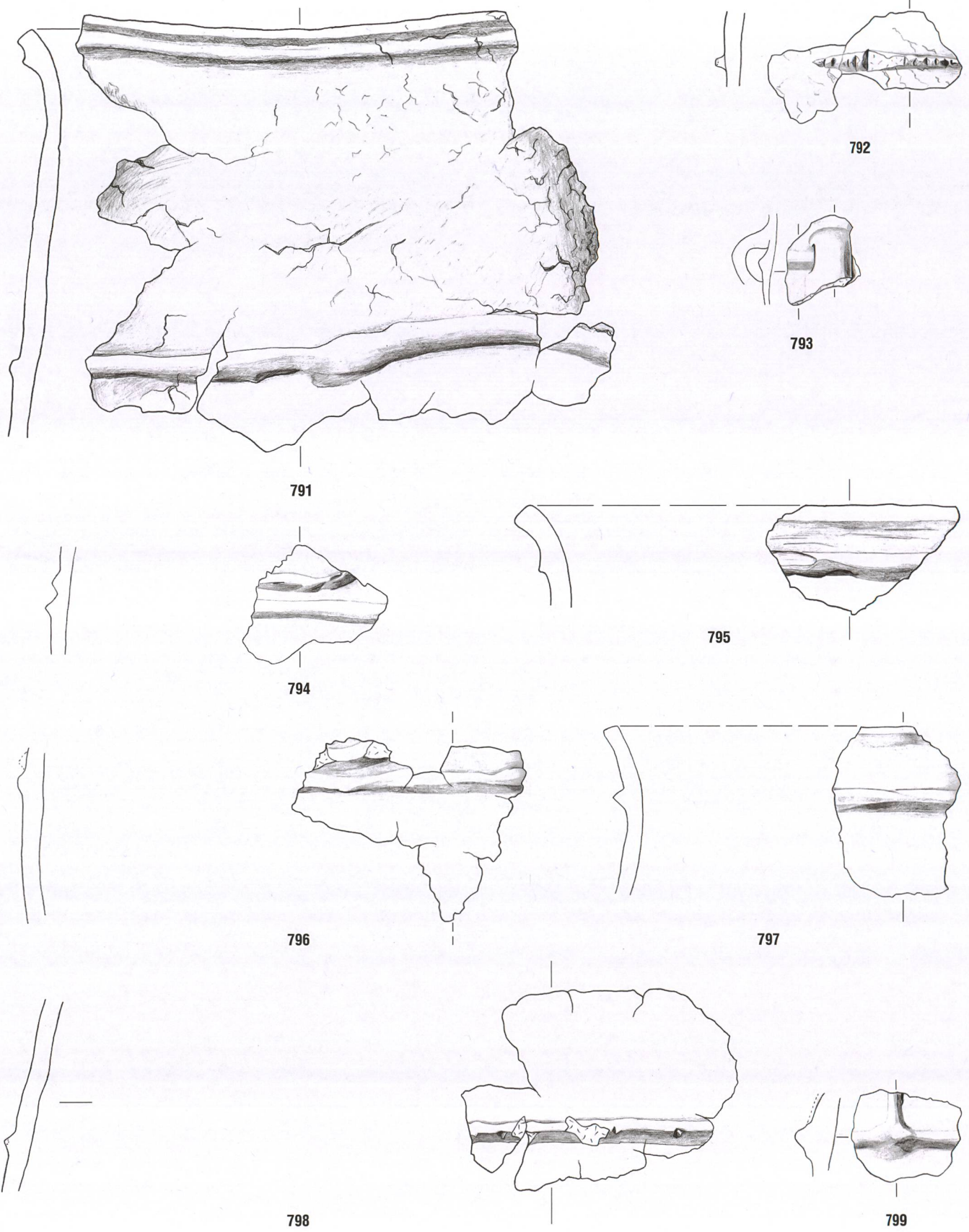

Tafel 62: Cazis, Cresta 1947-1970. Südliche Zentralspalte, Keramikhorizont KH III. 791-799: Planum 10S. Keramik. Mst. 1:3.

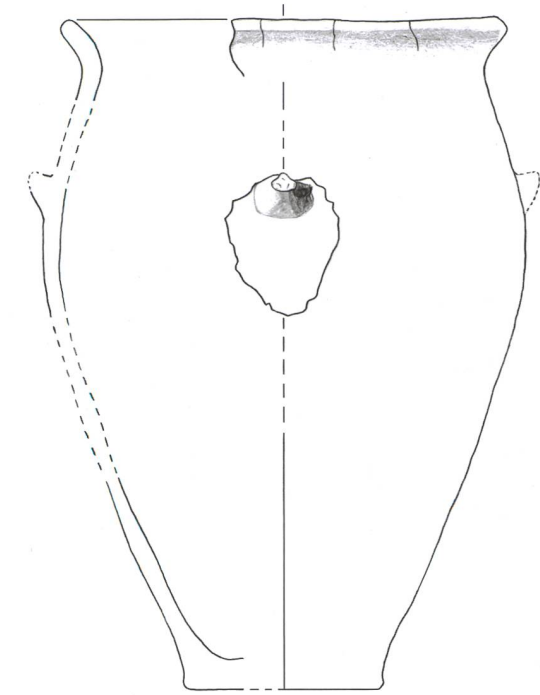

800

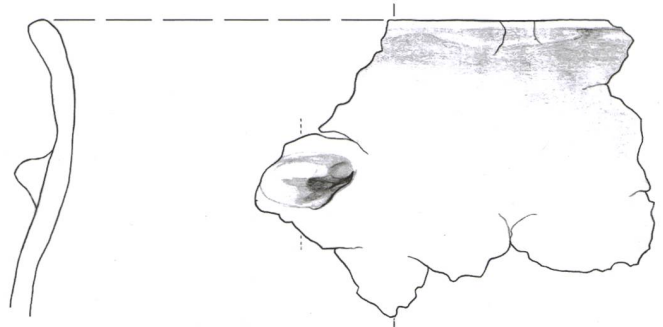

801

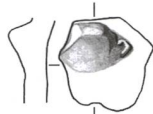

802

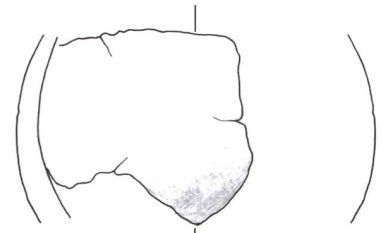

803

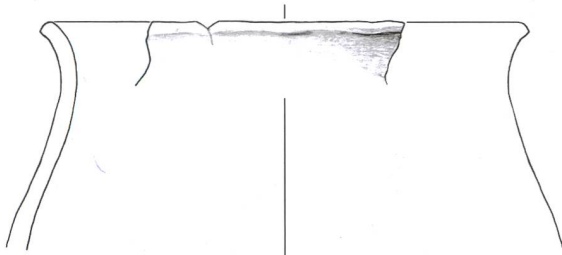

804

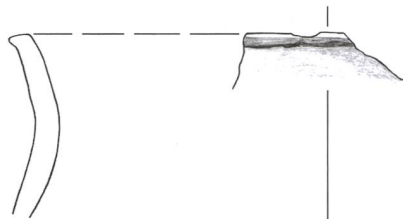

807

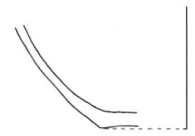

810

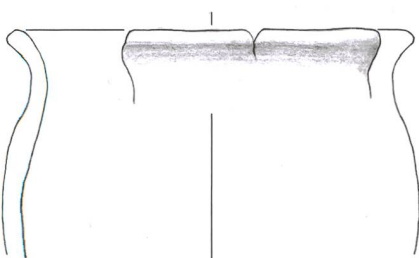

805

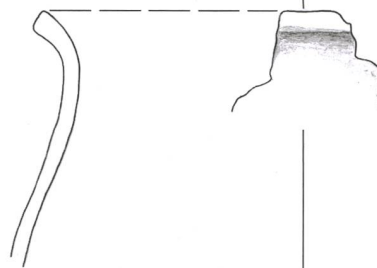

808



811

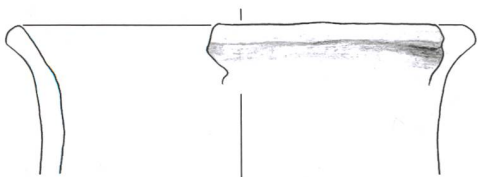

806

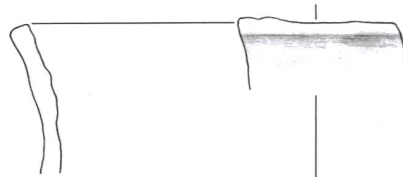

809

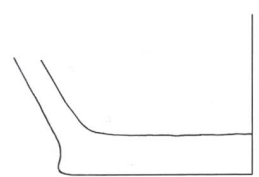

812

Tafel 63: Cazis, Cresta 1947-1970. Südliche Zentralspalte, Keramikhorizont KH III. 800-812: Planum 10S. Keramik. Mst. 1:3.

813-824

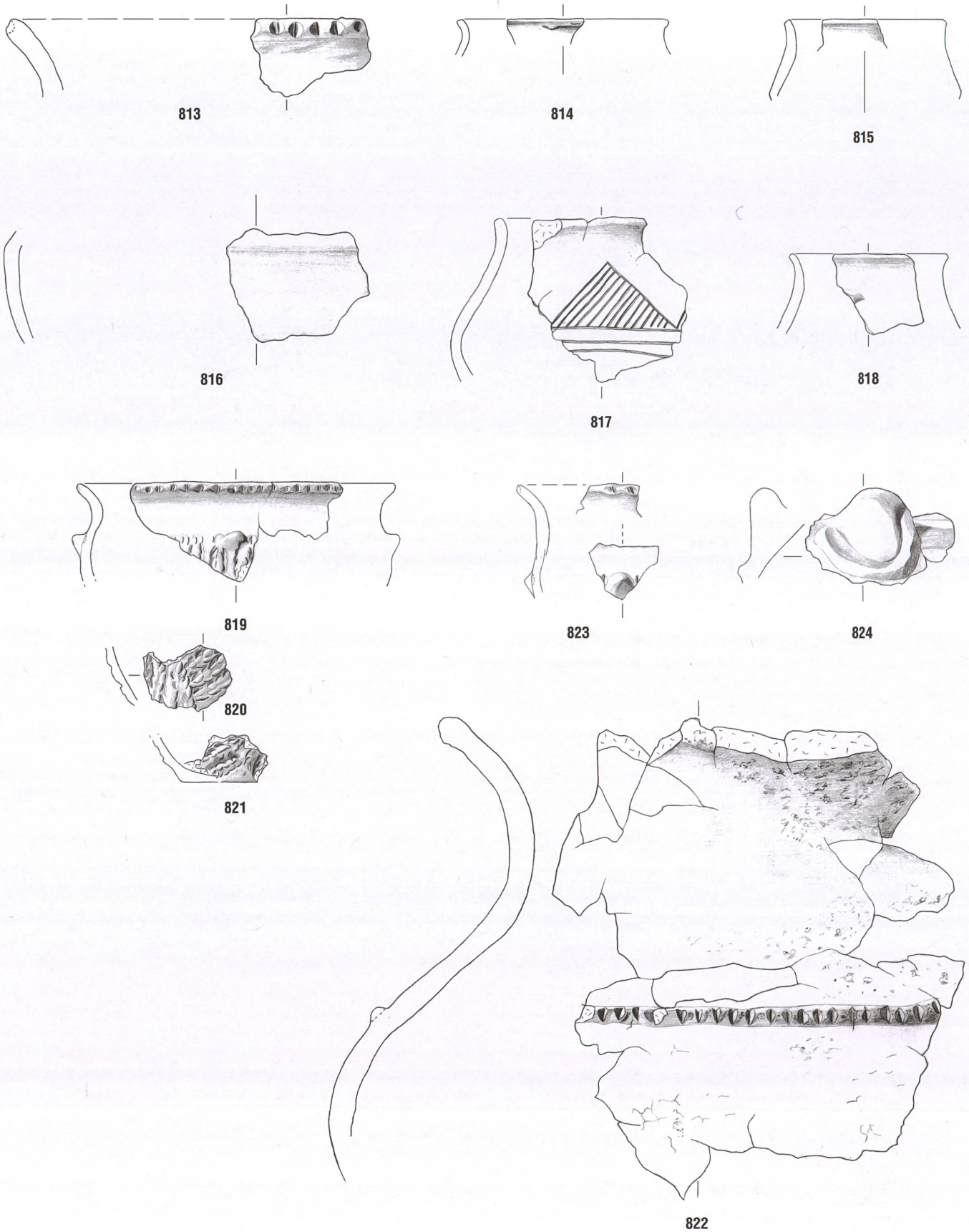

Tafel 64: Cazis, Cresta 1947-1970. Südliche Zentralspalte, Keramikhorizont KH III. 813-821: Planum 10S. 822: Plana 10S-12S. Keramik. Mst. 1:3.

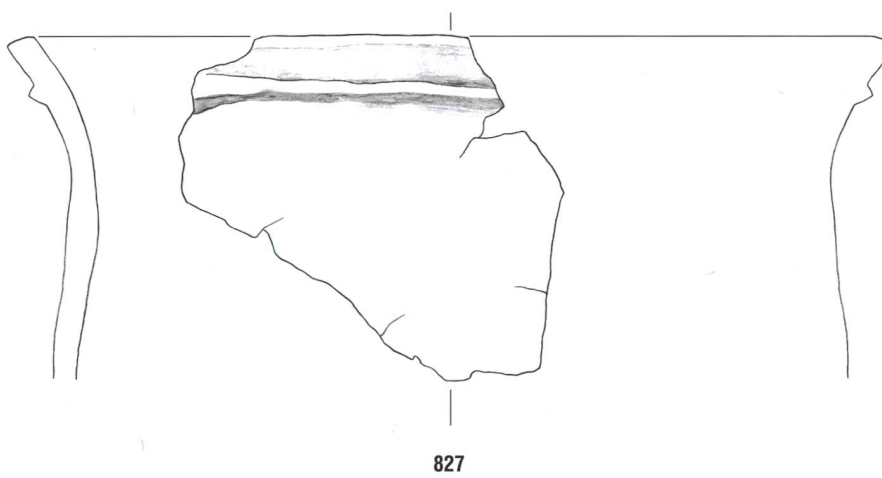
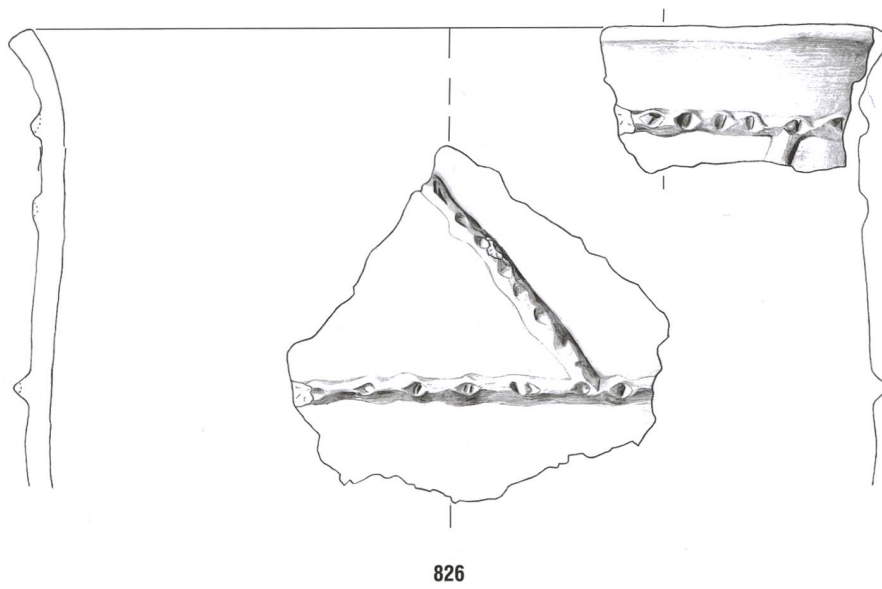
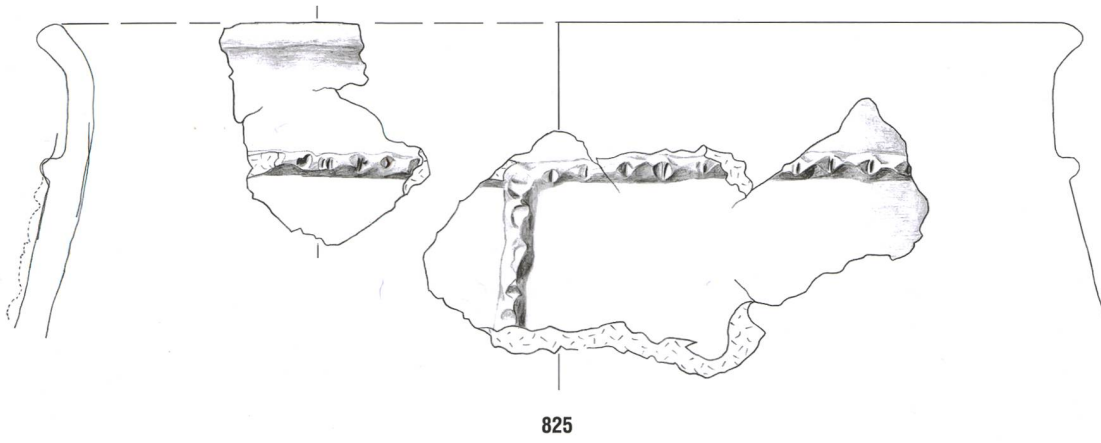

Tafel 65: Cazis, Cresta 1947-1970. Südliche Zentralspalte, Keramikhorizont KH III. 823-827: Planum 11S. Keramik. Mst. 1:3.

828-839

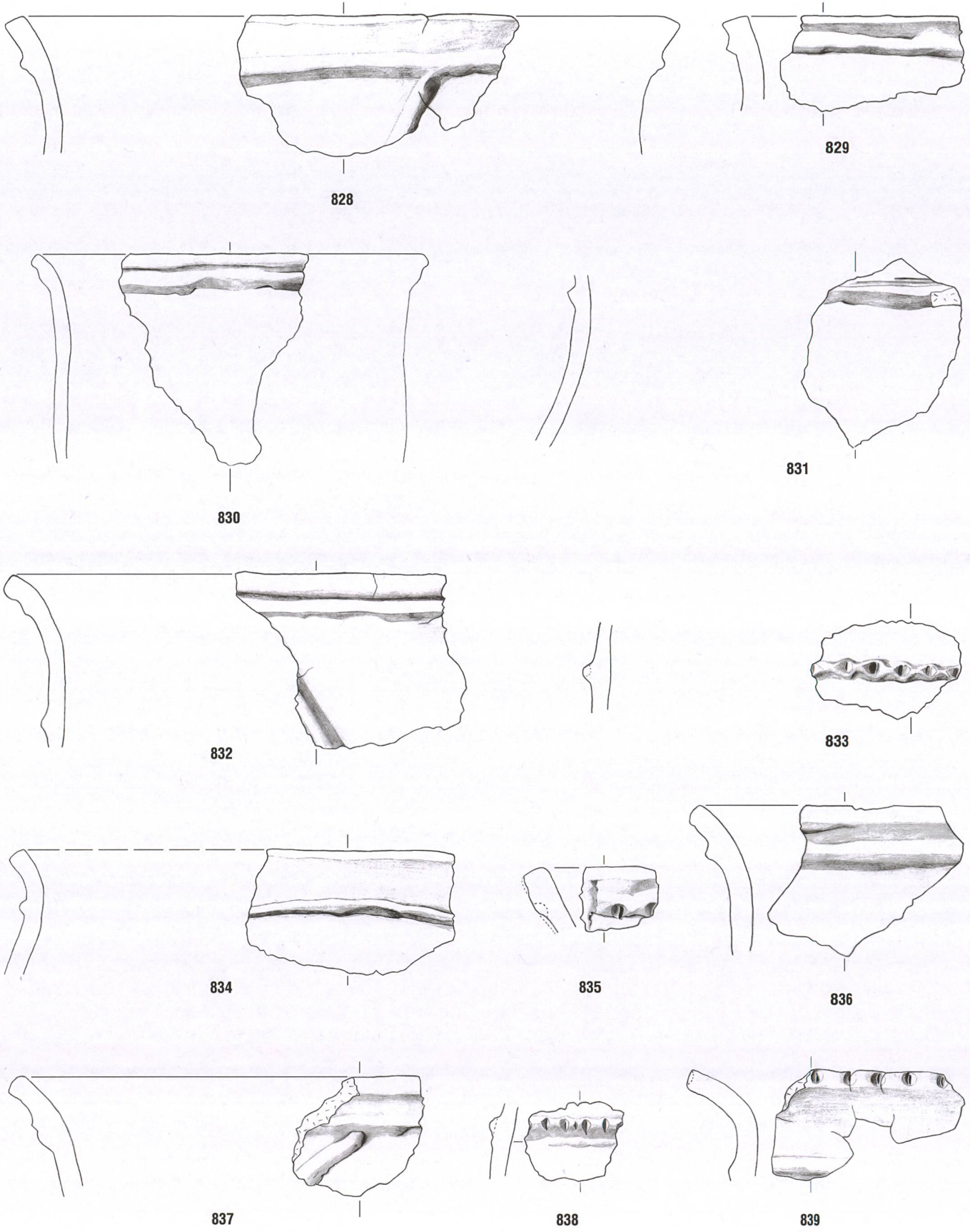

Tafel 66: Cazis, Cresta 1947-1970. Südliche Zentralspalte, Keramikhorizont KH III. 828-839: Planum 11S. Keramik. Mst. 1:3.



840-844

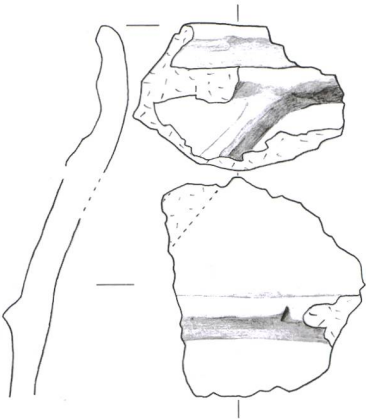

840

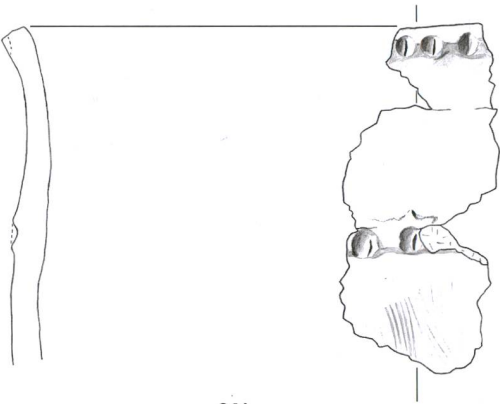

841

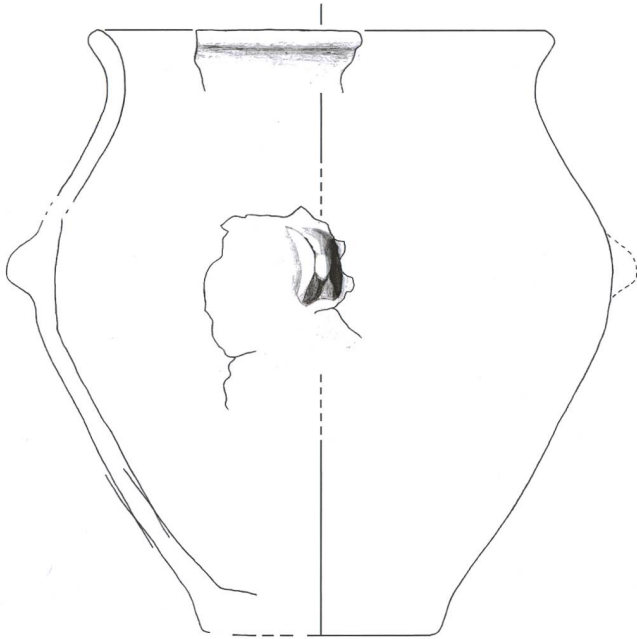

842

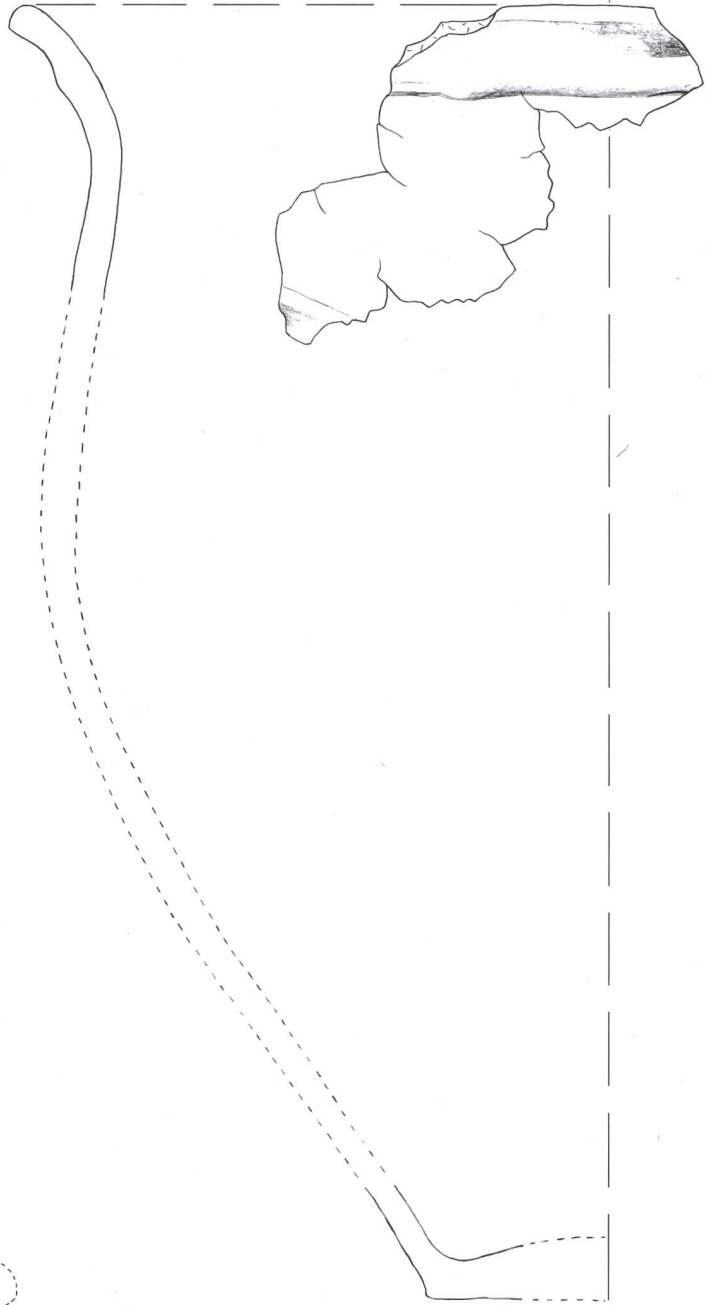

843

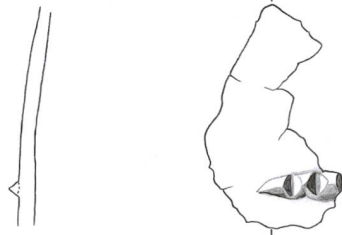

844

Tafel 67: Cazis, Cresta 1947-1970. Südliche Zentralspalte, Keramikhorizont KH III. 840-844: Planum 11S. Keramik. Mst. 1:3.

845-858

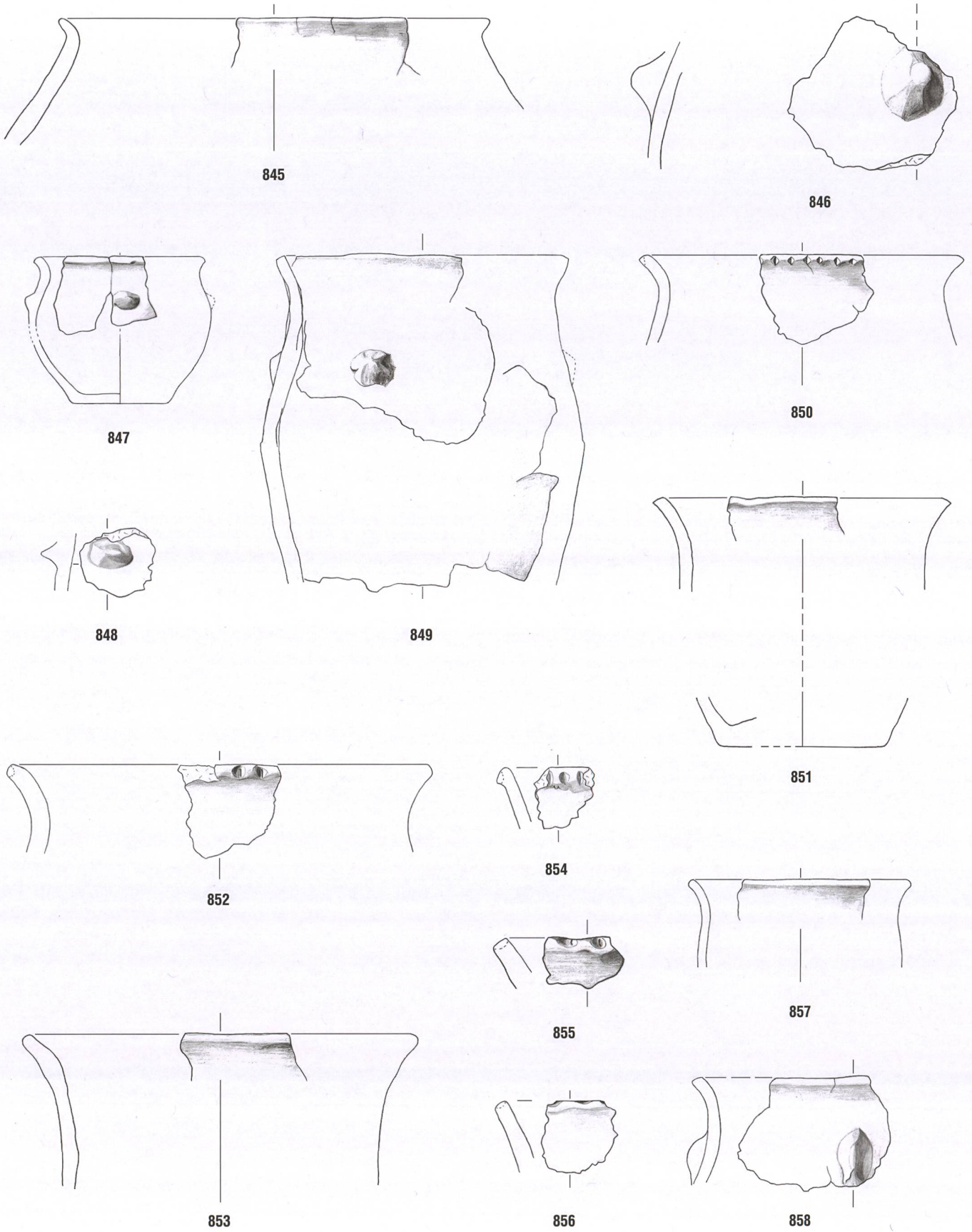

Tafel 68: Cazis, Cresta 1947-1970. Südliche Zentralspalte, Keramikhorizont KH III. 845-858: Planum 11S. Keramik. Mst. 1:3.

859-875

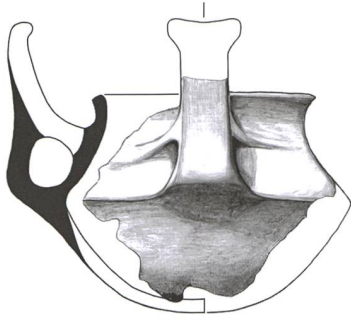

859

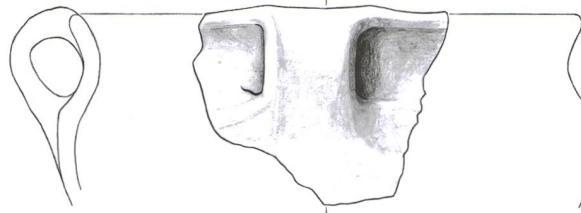

860

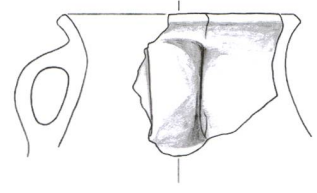

861

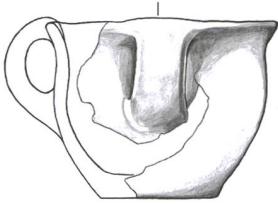

862

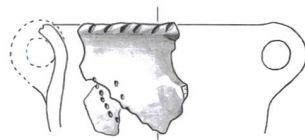

863

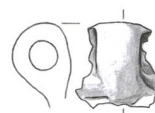

864

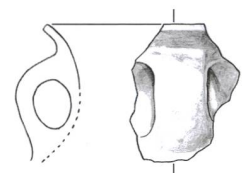

865

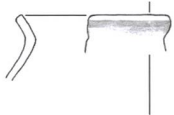

866



867

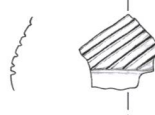

868

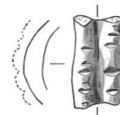

869

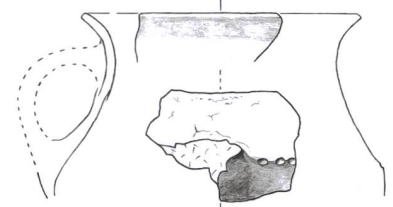

870

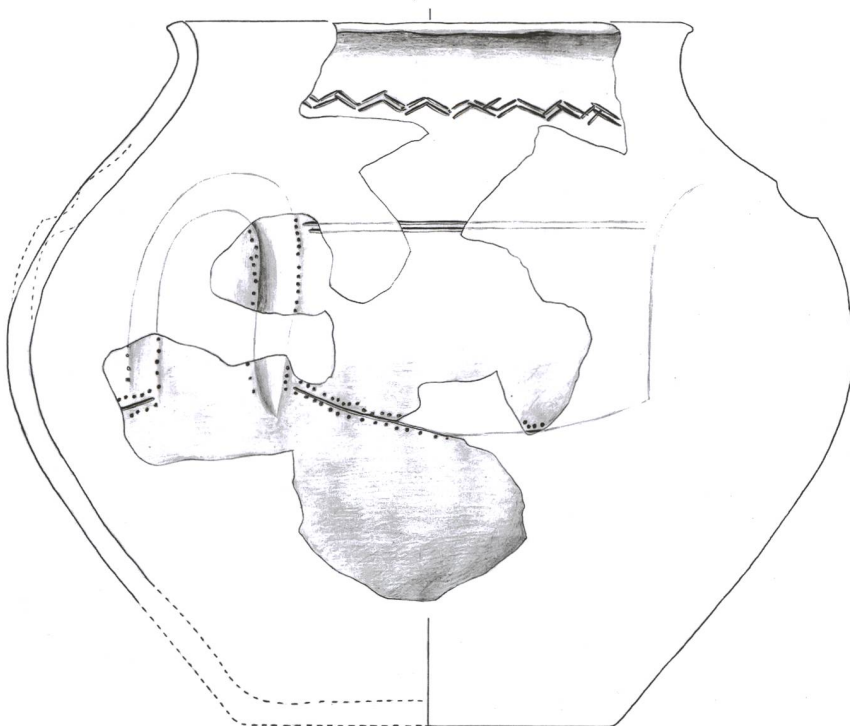

871

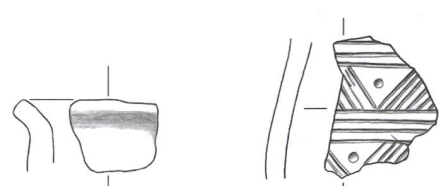

872

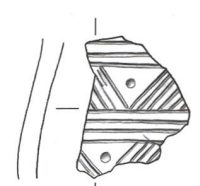

873

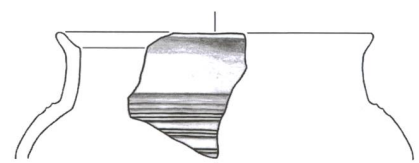

874

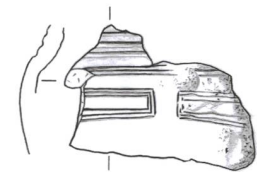

875

Tafel 69: Cazis, Cresta 1947-1970. Südliche Zentralspalte, Keramikhorizont KH III. 859-871: Planum 11S. Keramikhorizont KH IV. 872-875: Planum 11S, gestörter Bereich in Feld 12. Keramik. Mst. 1:3.

876-882

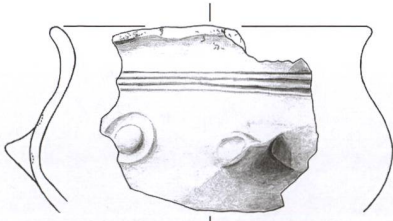

876

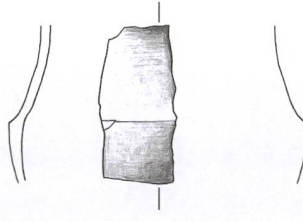

877

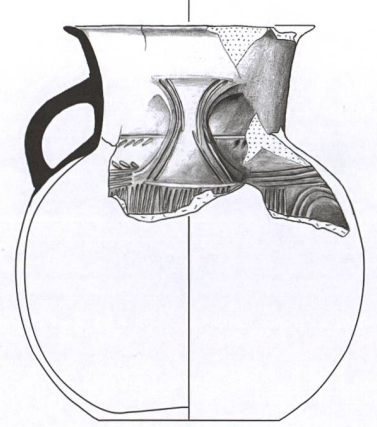

878

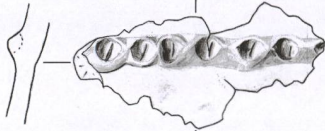

879

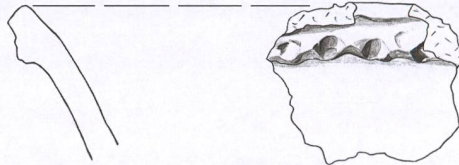

880

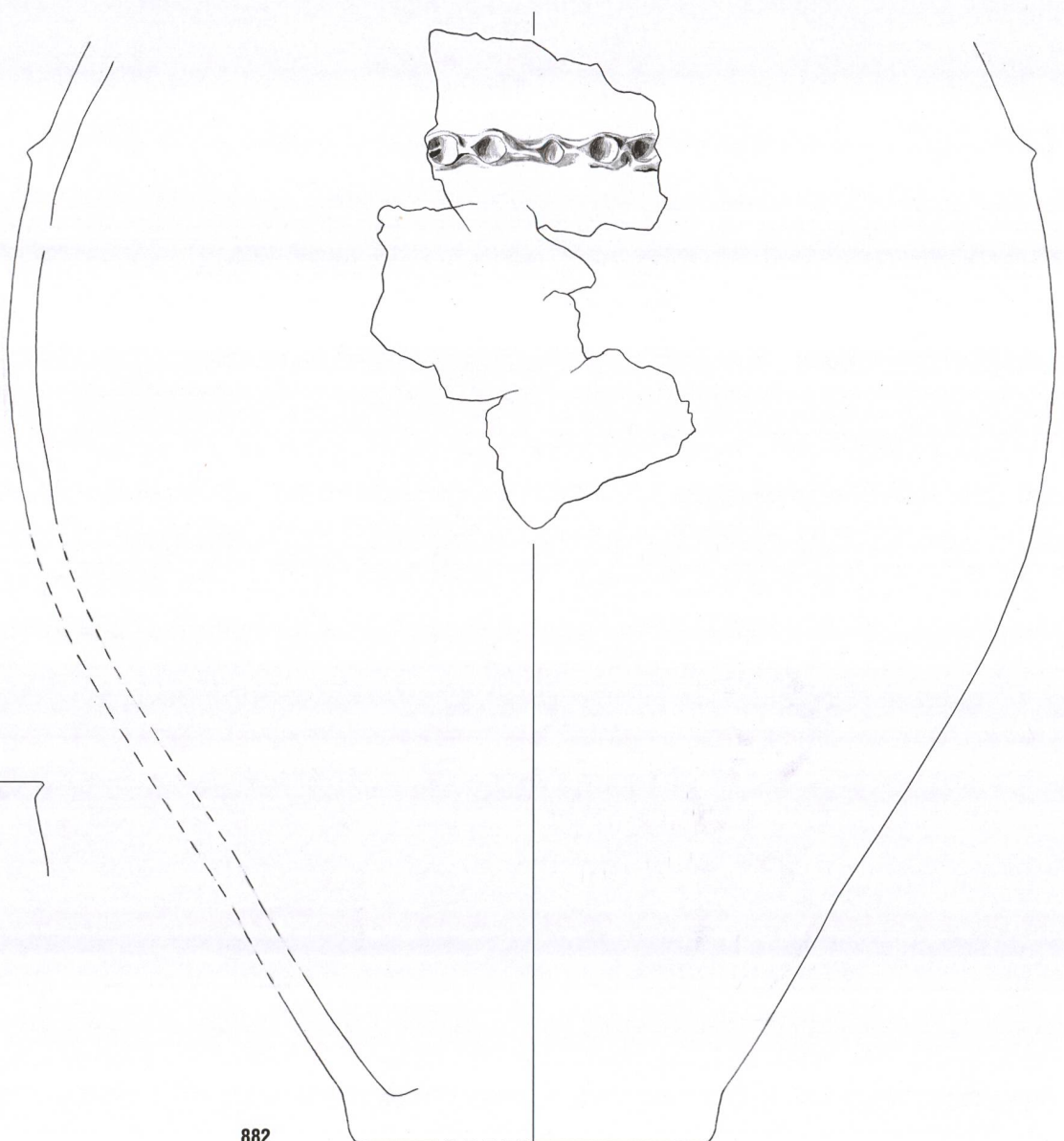

882

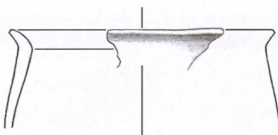

881

Tafel 70: Cazis, Cresta 1947-1970. Südliche Zentralspalte, Keramikhorizont KH III. 876-882: Planum 9S. Keramik. Mst. 1:3.

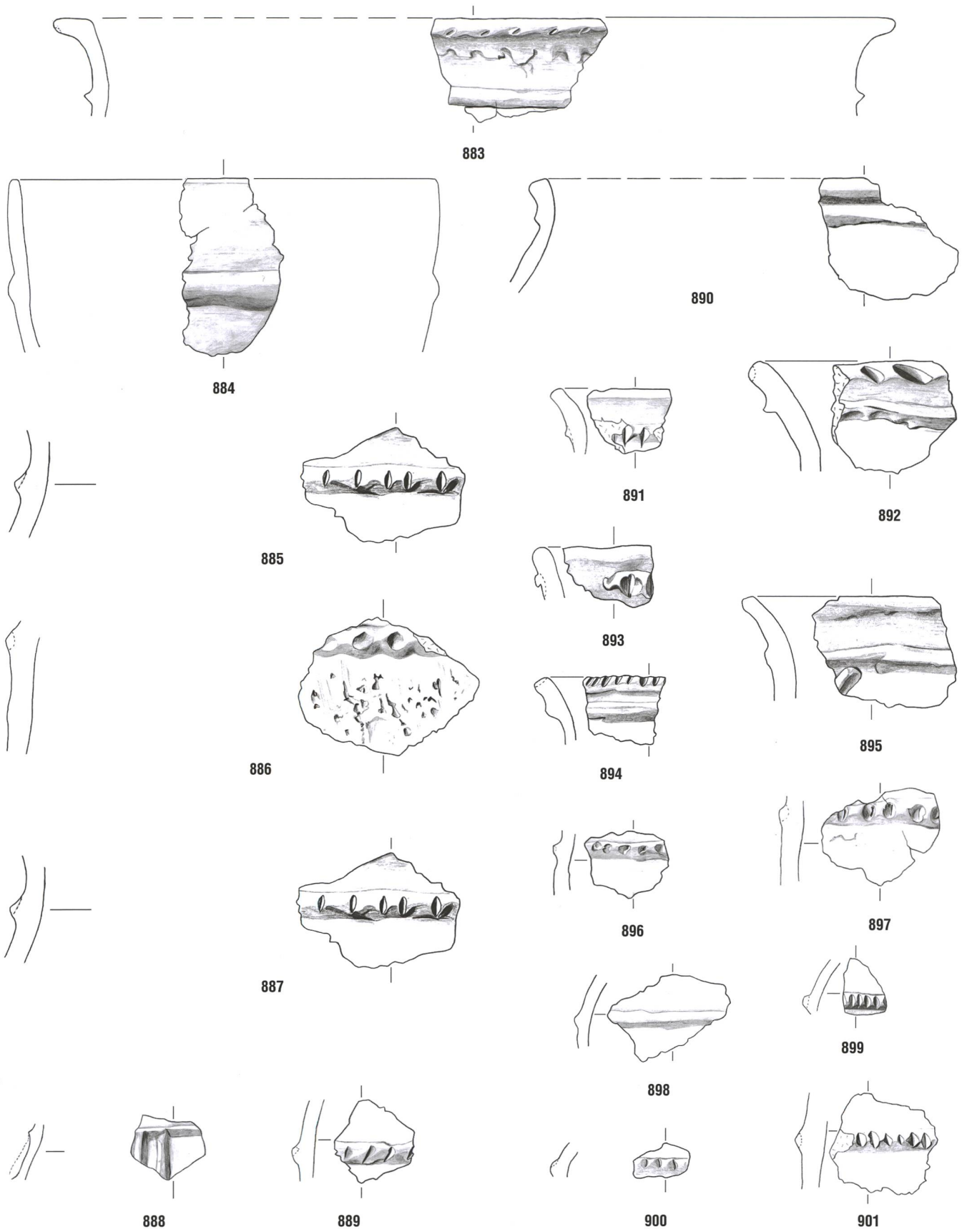

Tafel 71: Cazis, Cresta 1947-1970. Südliche Zentralspalte, Keramikhorizont KH IV. 883-901: Planum 12S. Keramik. Mst. 1:3.

902-920

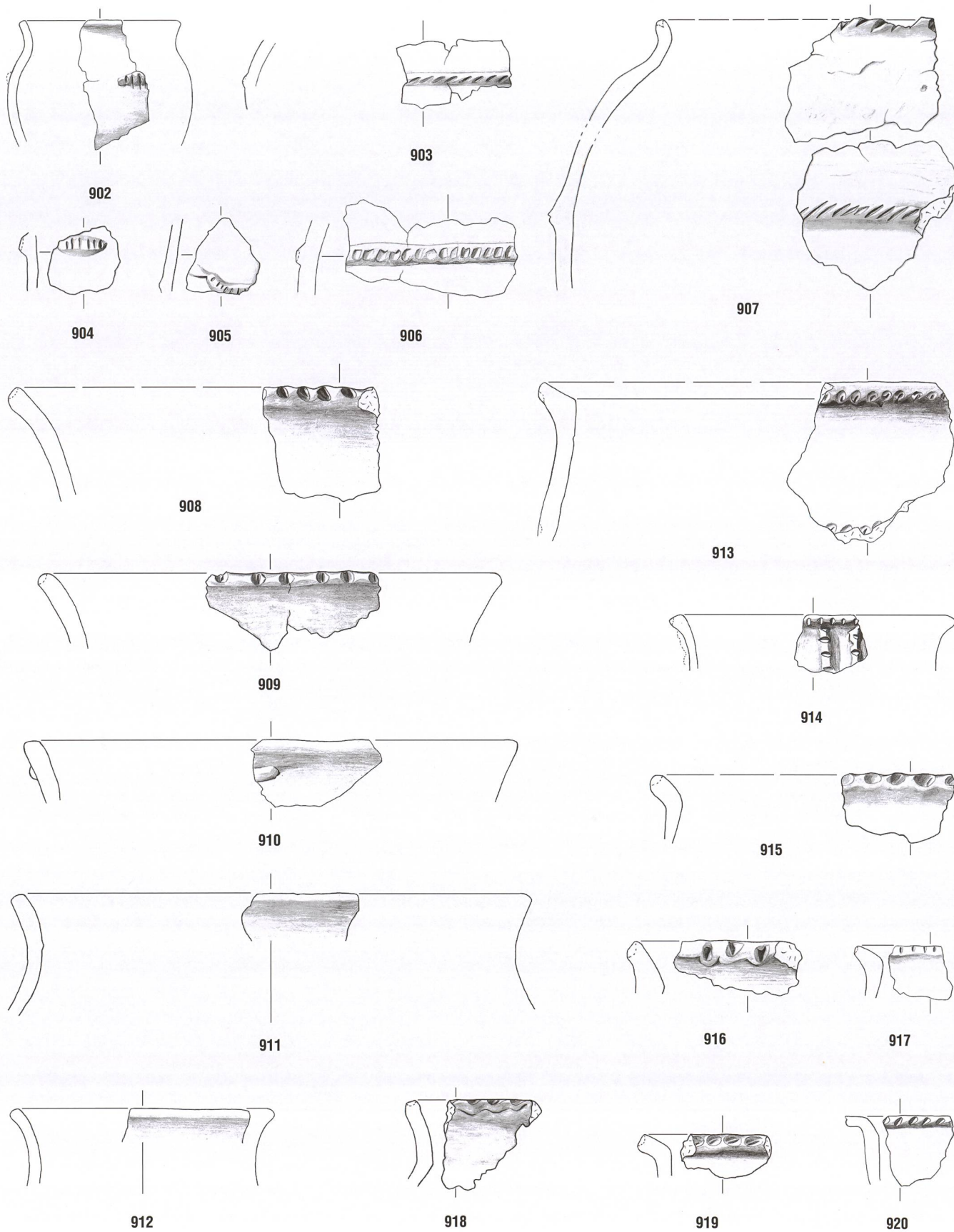

Tafel 72: Cazis, Cresta 1947-1970. Südliche Zentralspalte, Keramikhorizont KH IV. 902-912, 914-920: Planum 12S. 913: Plana 9S-12S. Keramik. Mst. 1:3.

921-940

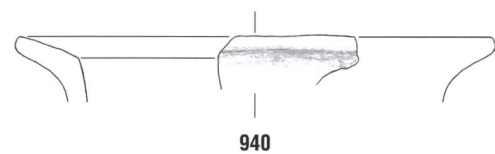
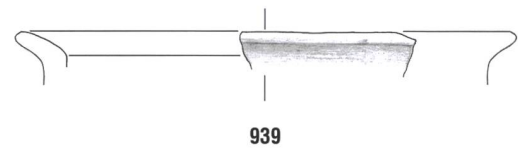
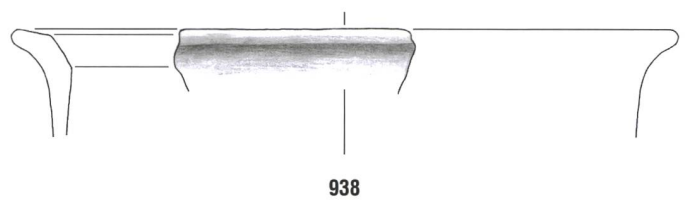
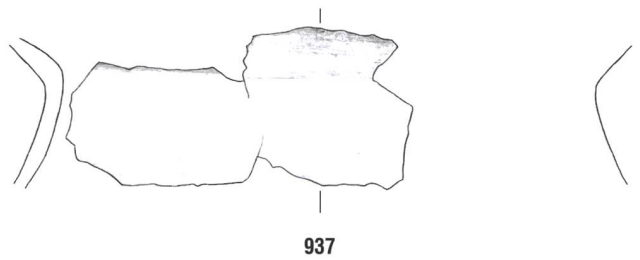
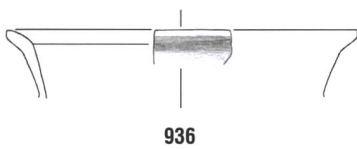
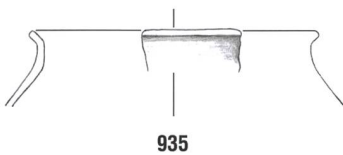
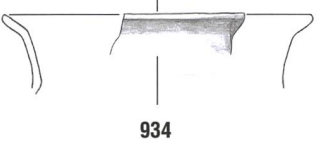
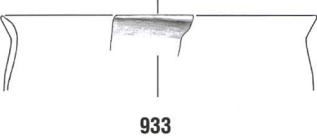
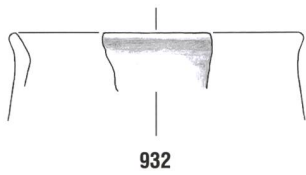
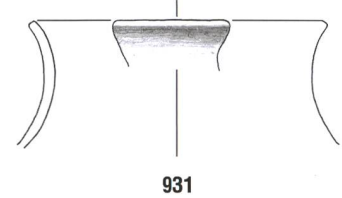
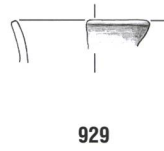
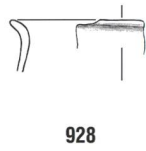
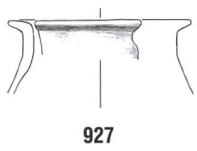
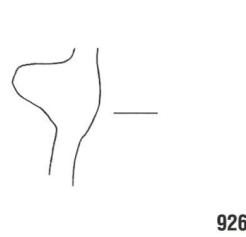
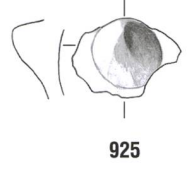
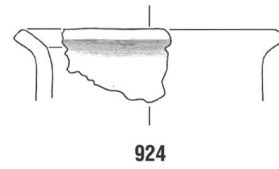
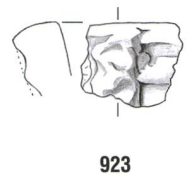
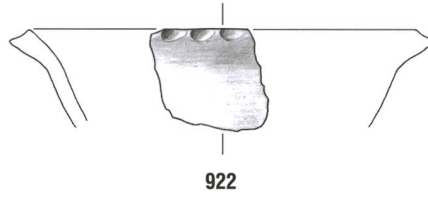
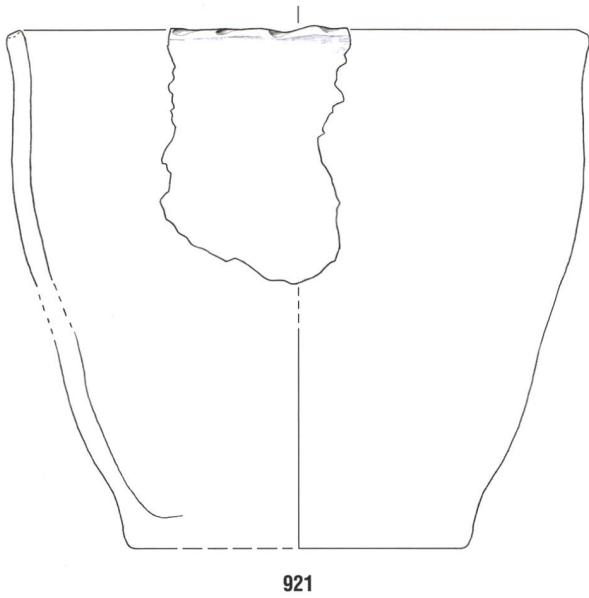

Tafel 73: Cazis, Cresta 1947-1970. Südliche Zentralspalte, Keramikhorizont KH IV. 921-940: Planum 12S. Keramik. Mst. 1:3.

941-965

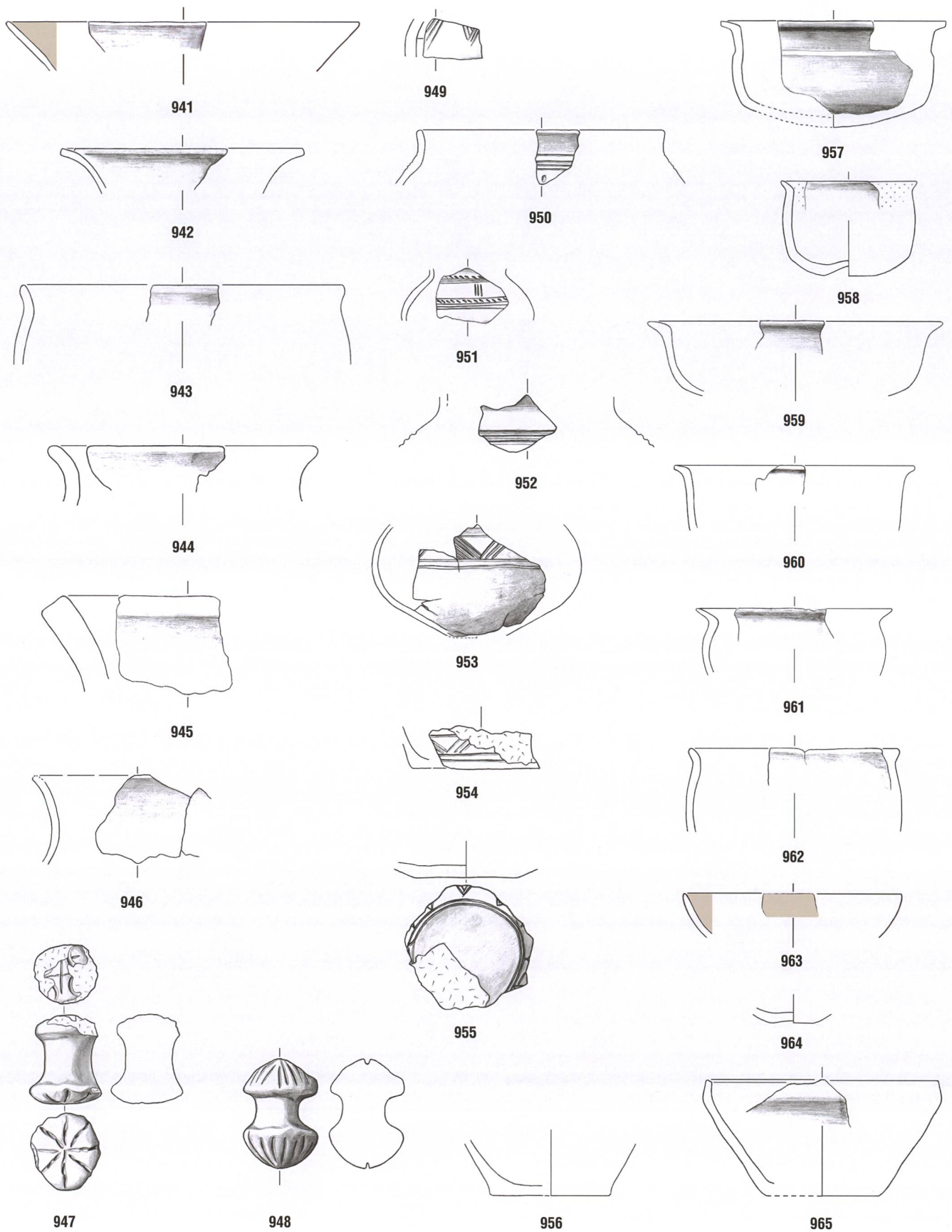

Tafel 74: Cazis, Cresta 1947-1970. Südliche Zentralspalte, Keramikhorizont KH IV. 941-965: Planum 12S. Keramik. Mst. 1:3.

966-983

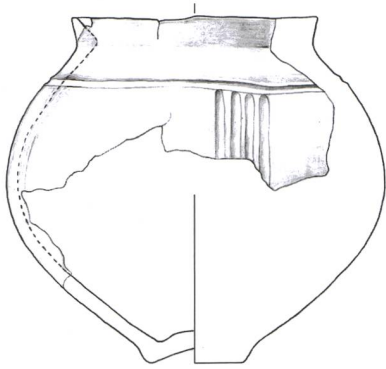

966

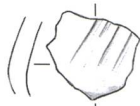

967



968

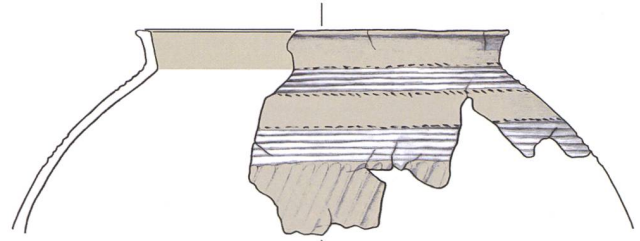

969



970



971



972



973

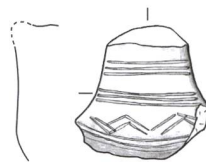

974

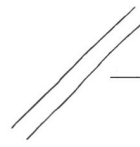

975

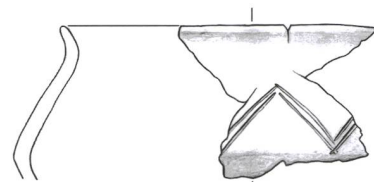
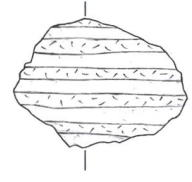

976

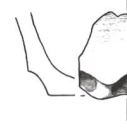

977



978

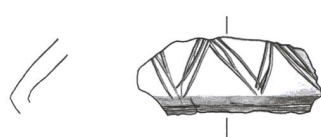
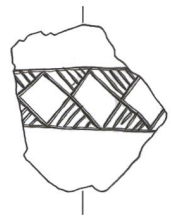

979

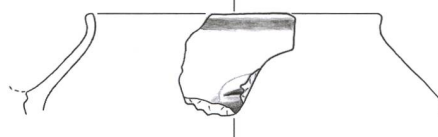

980

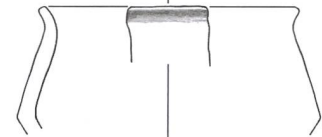

981

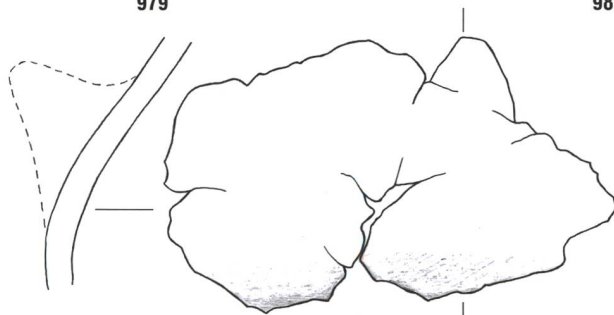

982

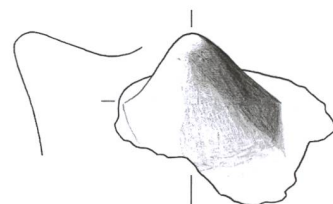

983

Tafel 75: Cazis, Cresta 1947-1970. Südliche Zentralspalte, Keramikhorizont KH IV. 966-983: Planum 12S. Keramik. Mst. 1:3.

984-1007

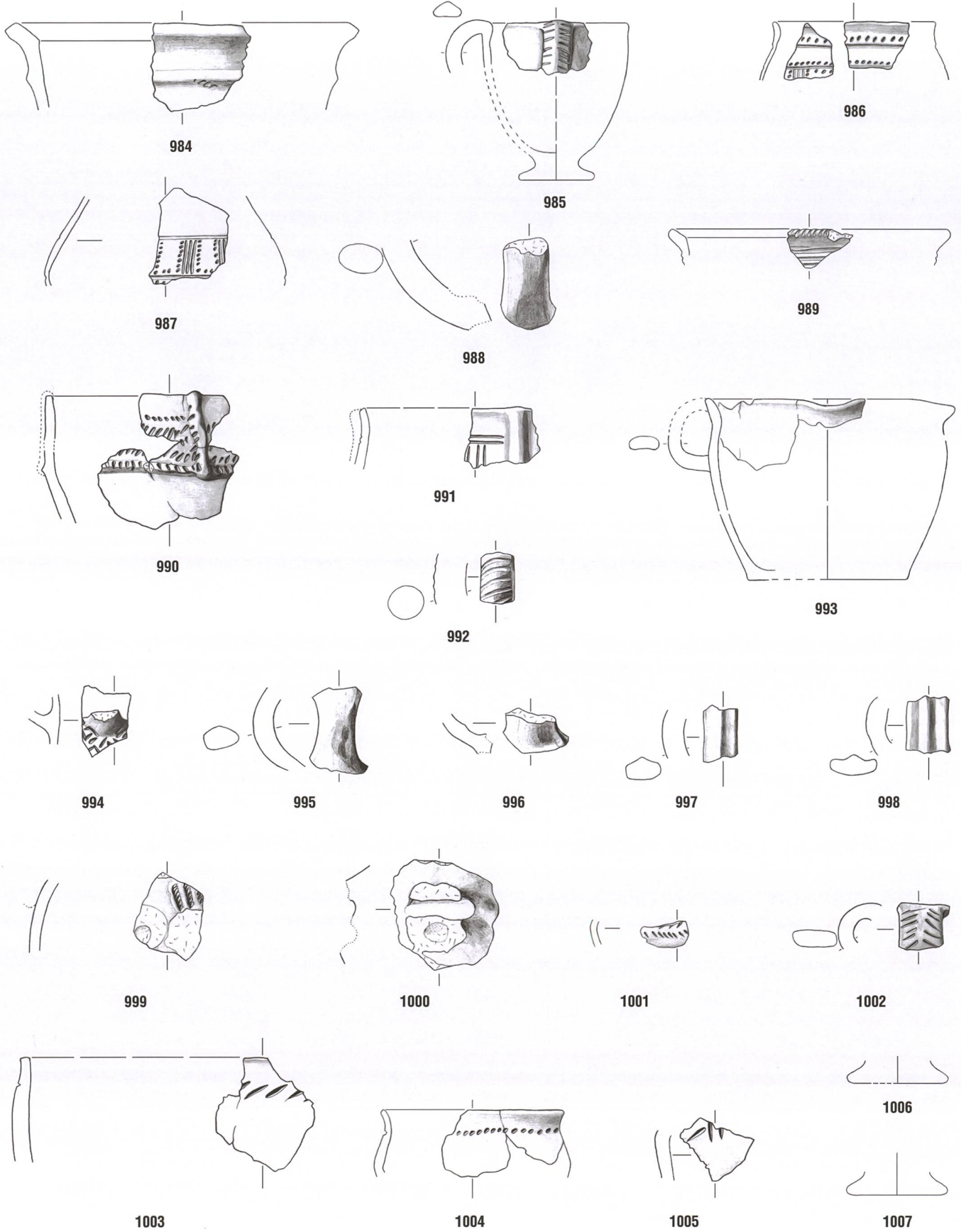

Tafel 76: Cazis, Cresta 1947-1970. Südliche Zentralspalte, Keramikhorizont KH IV. 984-1007: Planum 12S. Keramik. Mst. 1:3.

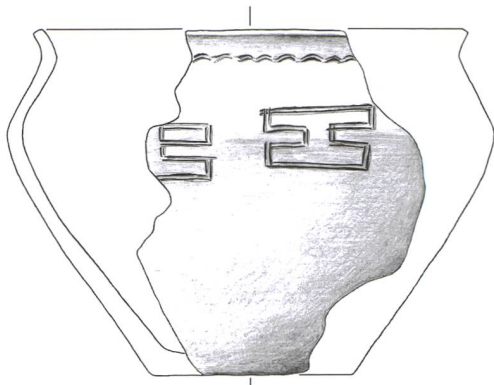

1008

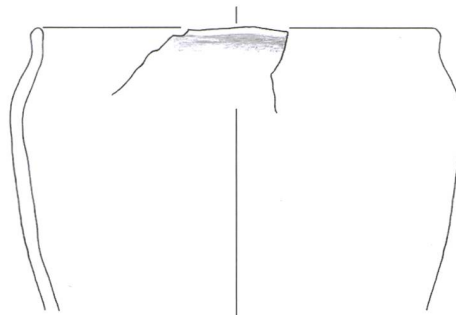

1009

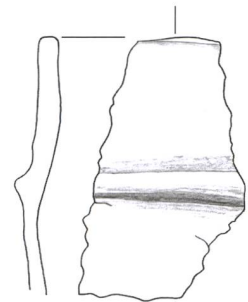

1012

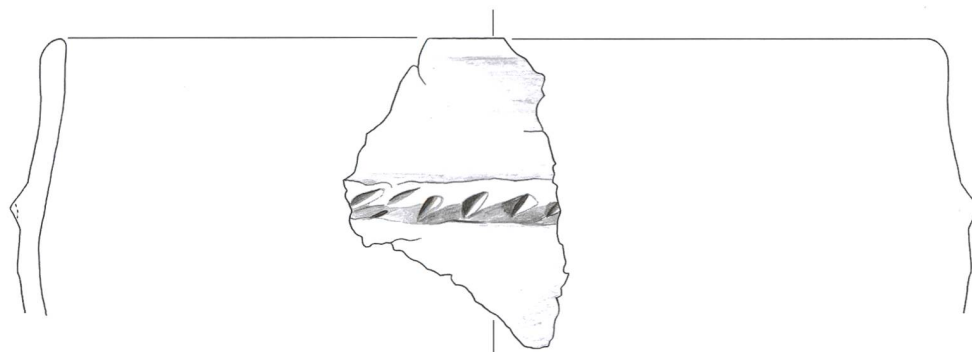

1010

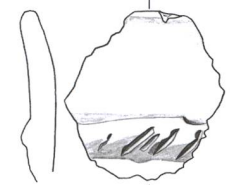

1013

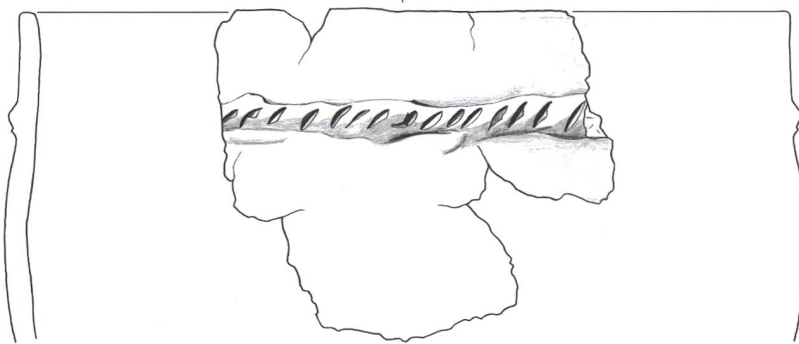

1011

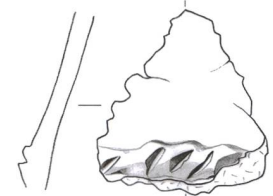

1014

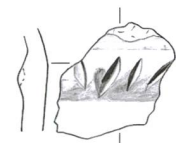

1015

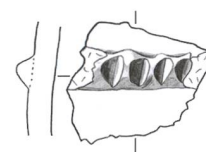

1016

Tafel 77: Cazis, Cresta 1947-1970. Südliche Zentralspalte, Keramikhorizont KH IV. 1008-1009: Planum 12S. 1010-1016: Planum 13S. Keramik. Mst. 1:3.

1017–1030

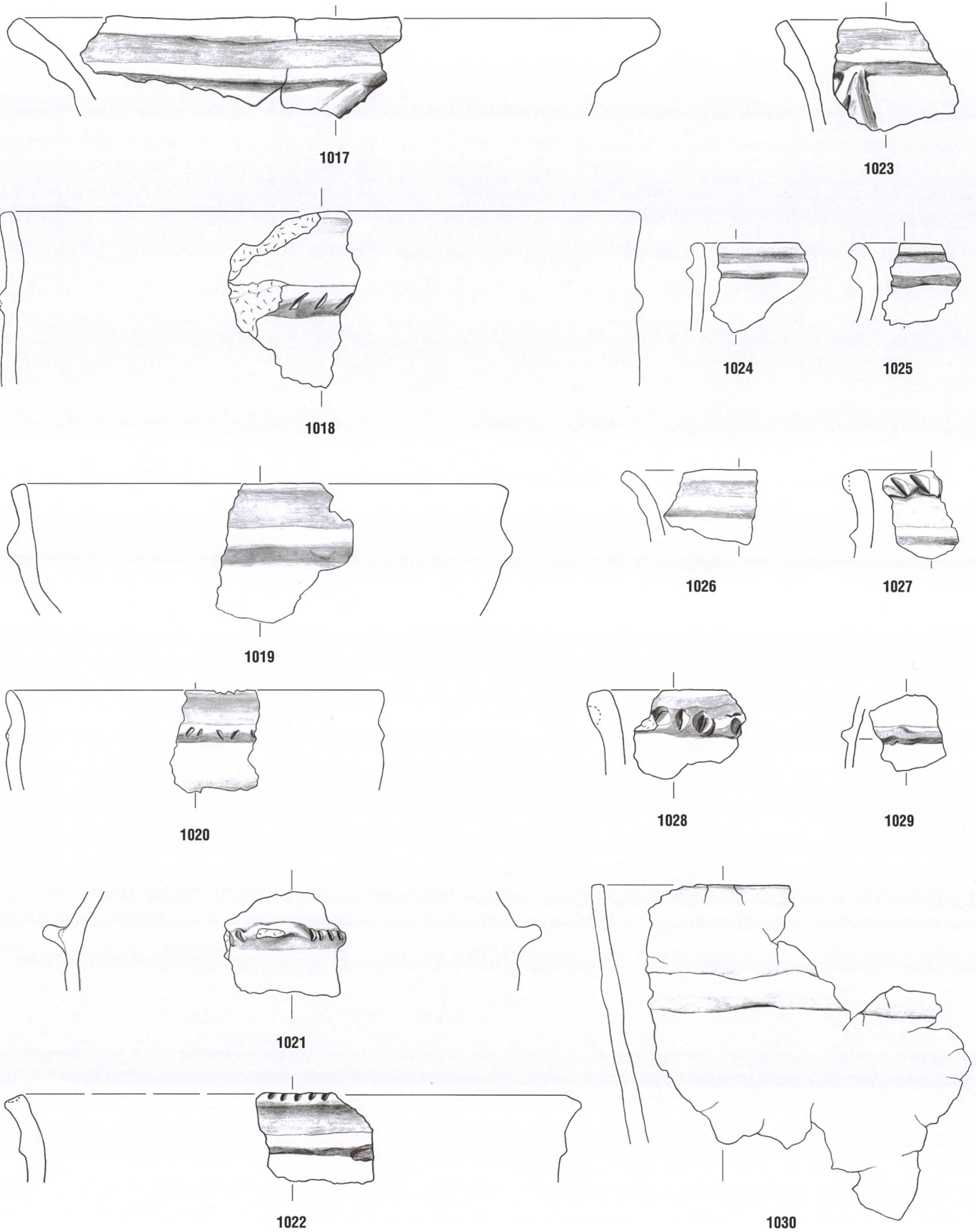

Tafel 78: Cazis, Cresta 1947–1970. Südliche Zentralspalte, Keramikhorizont KH IV. 1017–1030: Planum 13S. Keramik. Mst. 1:3.

1031-1048

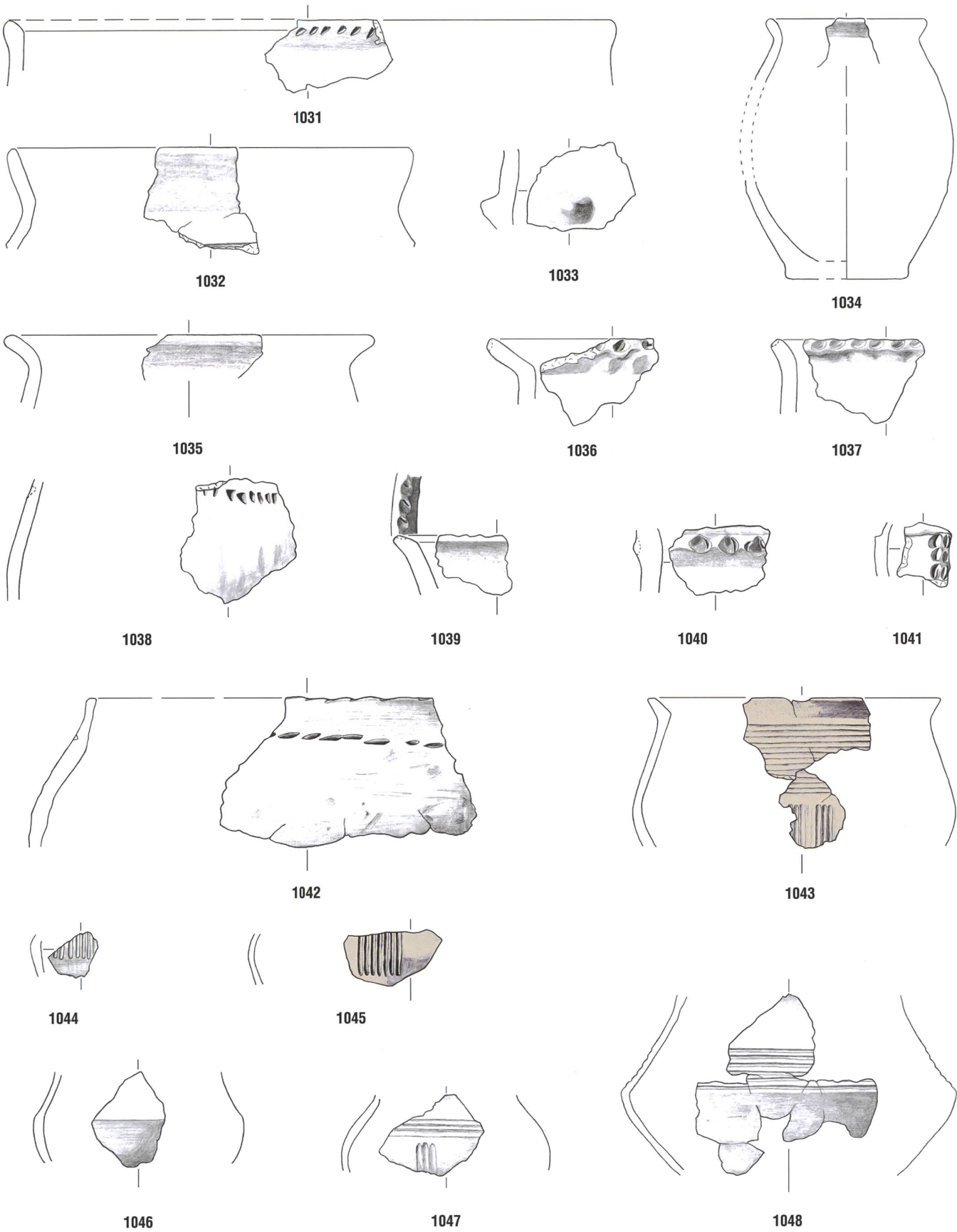

Tafel 79: Cazis, Cresta 1947-1970. Südliche Zentralspalte, Keramikhorizont KH IV. **1031-1047:** Planum 13S. **1048:** Plana 12S-13S. Keramik. Mst. 1:3.

1049–1063

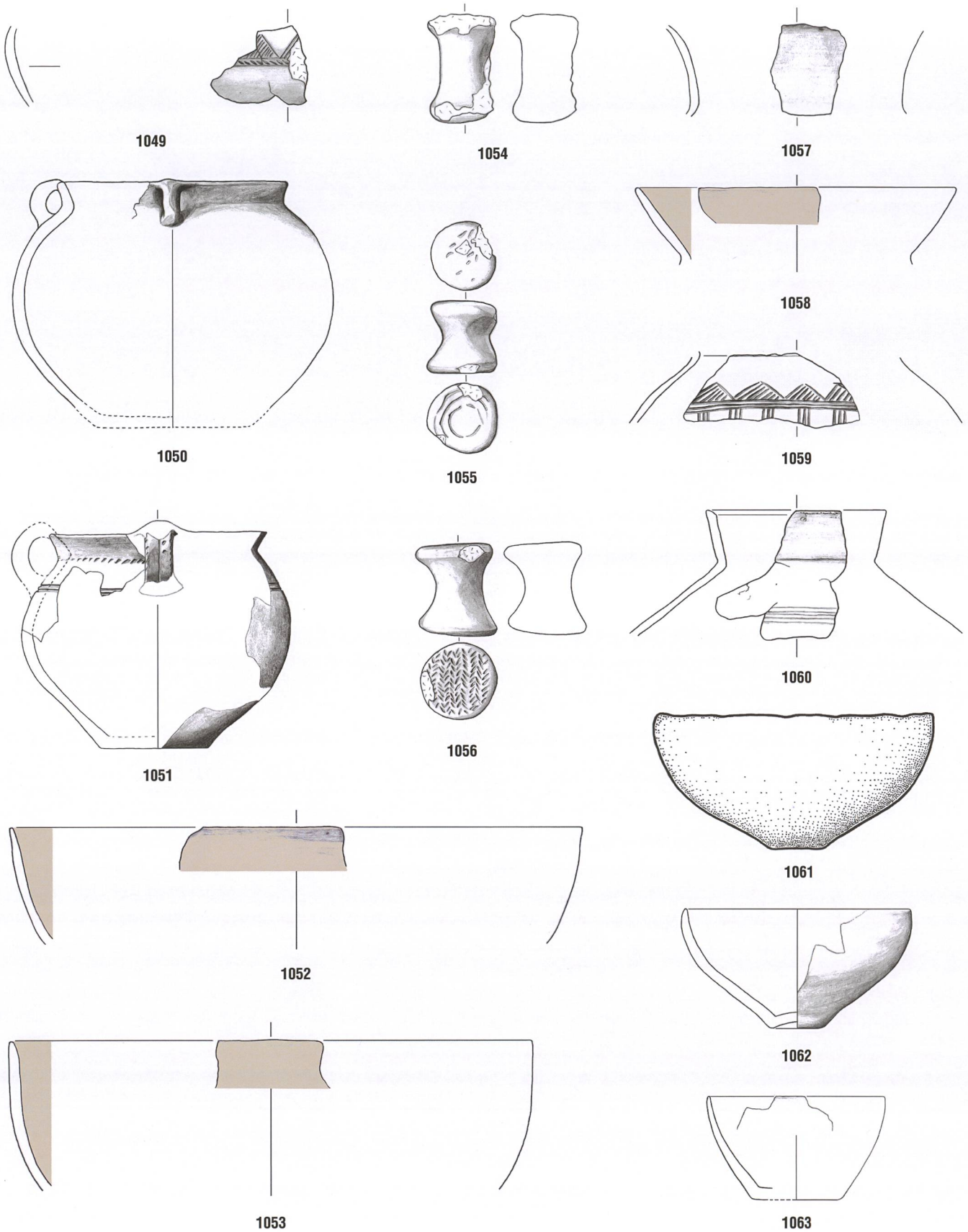

Tafel 80: Cazis, Cresta 1947–1970. Südliche Zentralspalte, Keramikhorizont KH IV. **1049:** Plana 12S–13S. **1050–1060, 1062–1063:** Planum 13S. **1061:** Plana 13S–14S. Keramik. Mst. 1:3.



1064-1082

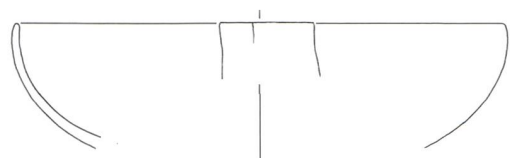

1064

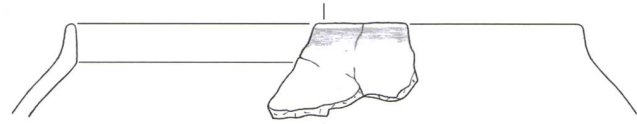

1071



1065



1072

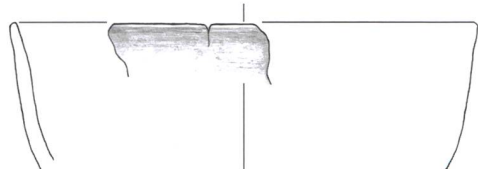

1066

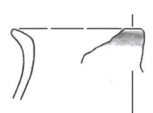

1078

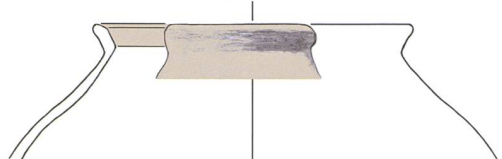

1073

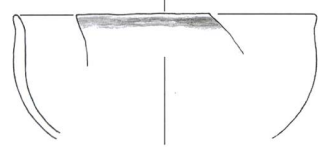

1067

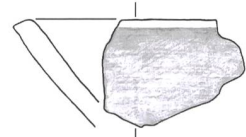

1079

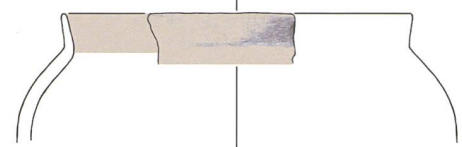

1074

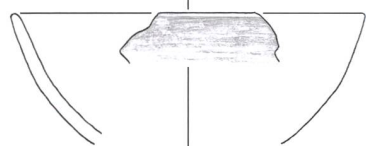

1068

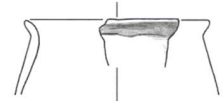

1080

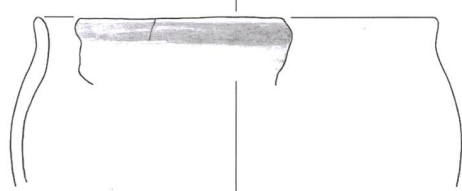

1075

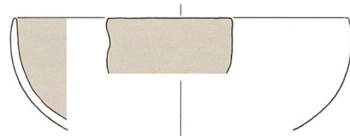

1069

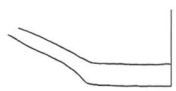

1081

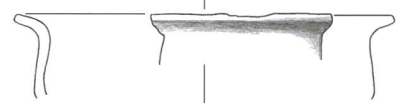

1076

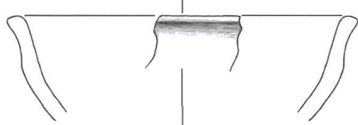

1070

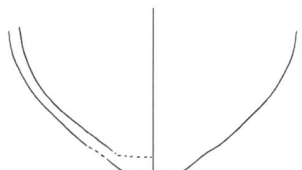

1082

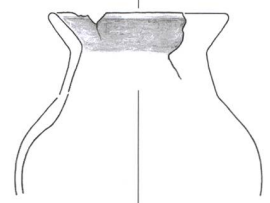

1077

Tafel 81: Cazis, Cresta 1947-1970. Südliche Zentralspalte, Keramikhorizont KH IV. 1064-1082: Planum 13S. Keramik. Mst. 1:3.

1083–1098

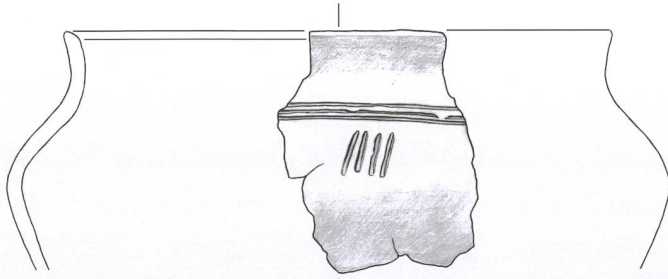

1083

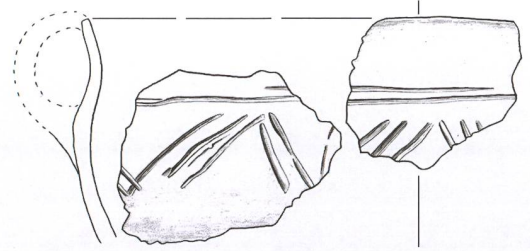

1091



1084

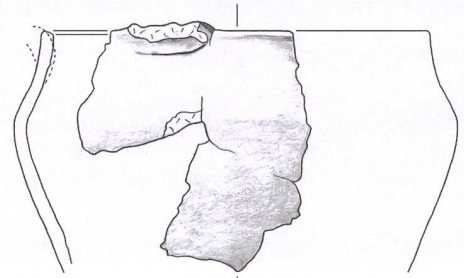

1092

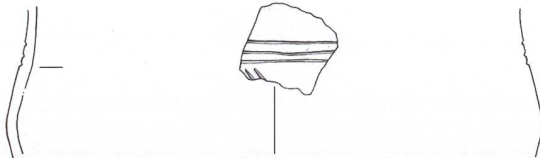

1085

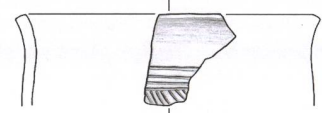

1093

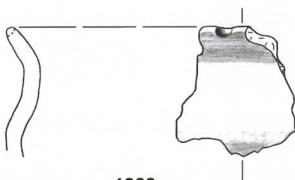

1086

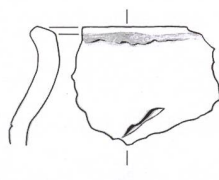

1087

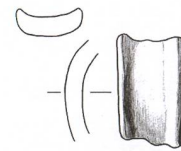

1094

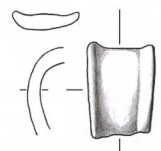

1095

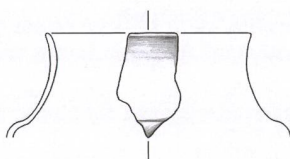

1088

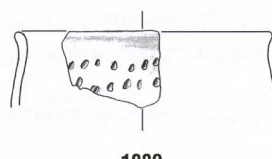

1089

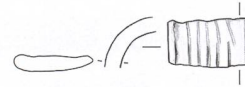

1096

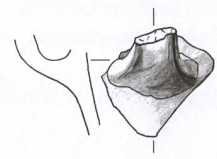

1097



1090



1098

Tafel 82: Cazis, Cresta 1947–1970. Südliche Zentralspalte, Keramikhorizont KH IV. 1083–1090, 1092–1098: Planum 13S. 1091: Plana 12S–13S. Keramik. Mst. 1:3.

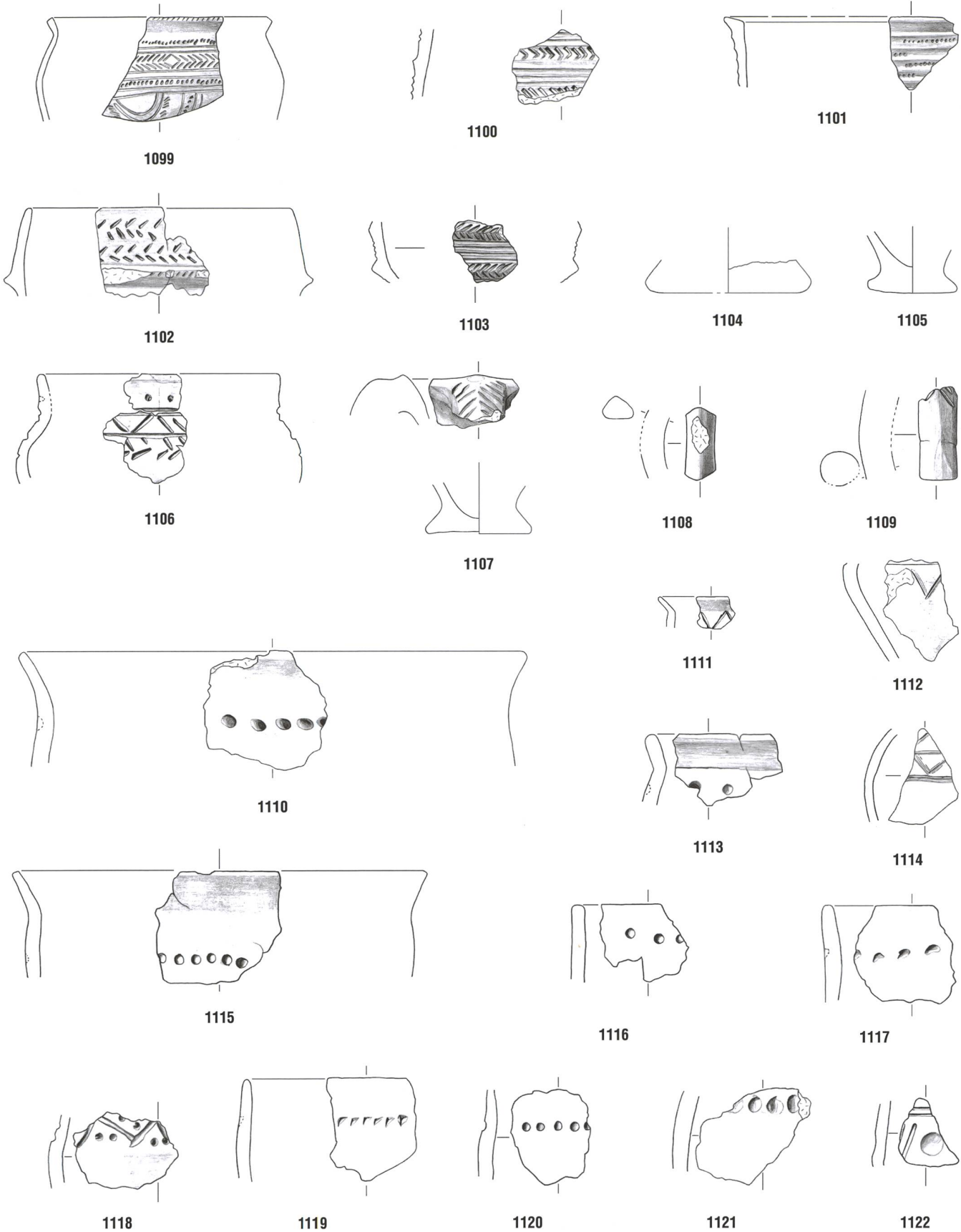

Tafel 83: Cazis, Cresta 1947-1970. Südliche Zentralspalte, Keramikhorizont KH IV. **1099, 1101-1122:** Planum 13S. **1100:** Plana 12S-13S. Keramik. Mst. 1:3.

1123-1134

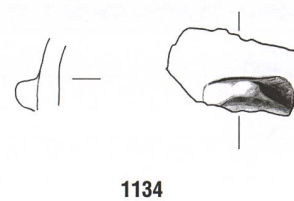
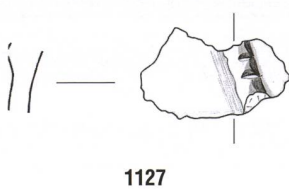
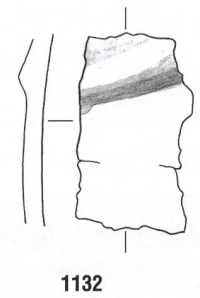
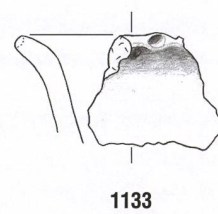
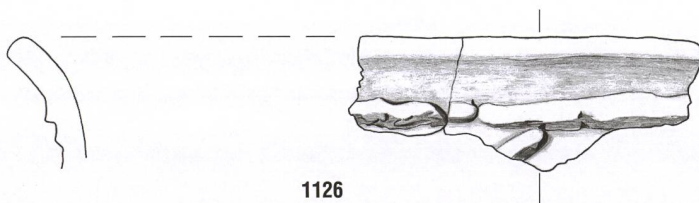
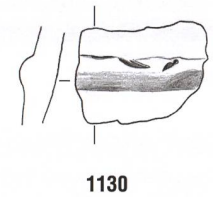
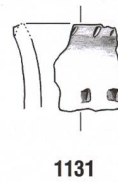
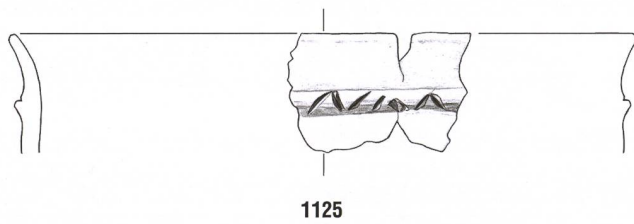
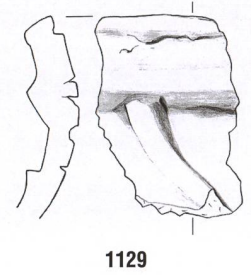
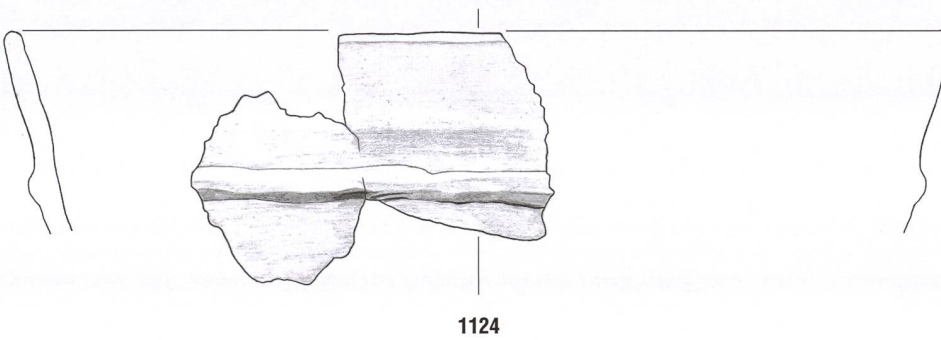
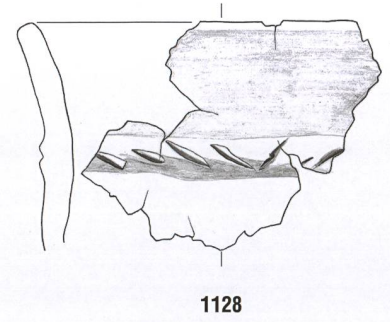
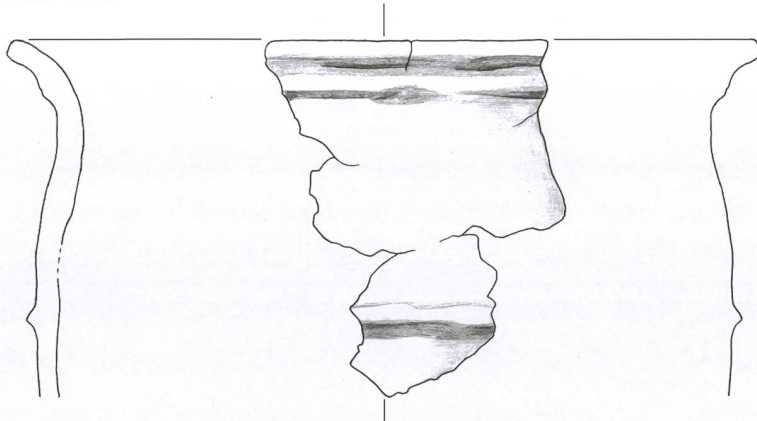

Tafel 84: Cazis, Cresta 1947-1970. Südliche Zentralspalte, Keramikhorizont KH IV. 1123-1134: Planum 14S. Keramik. Mst. 1:3.



1135-1149

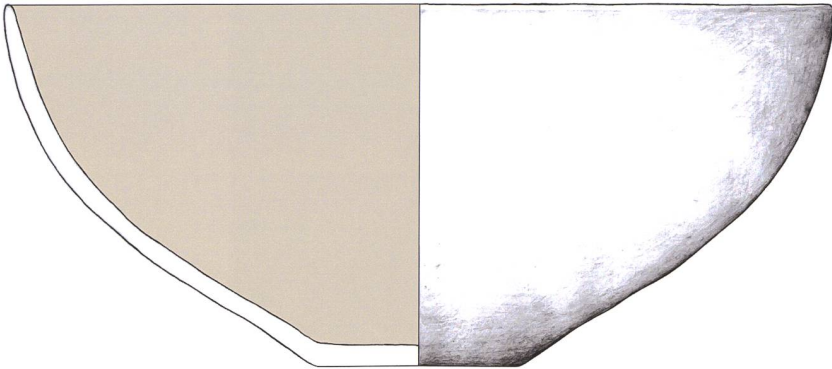

1135

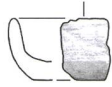

1140



1141



1142



1143

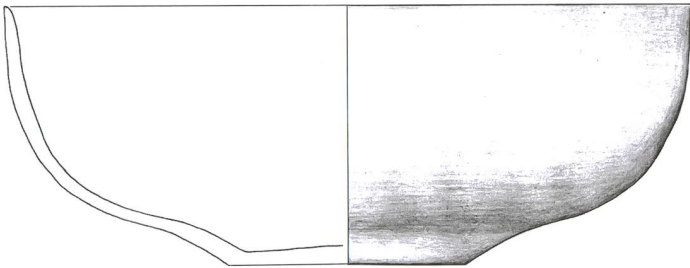

1136



1144

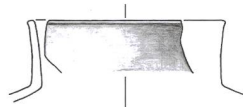

1145

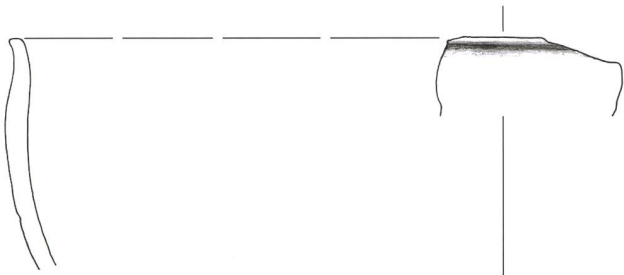

1137

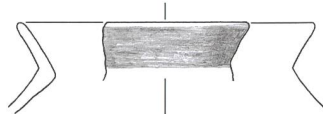

1146

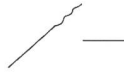

1147

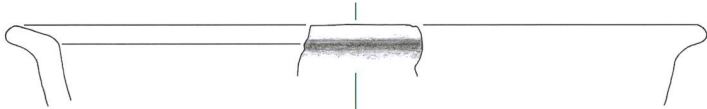
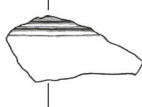

1138

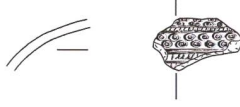

1148

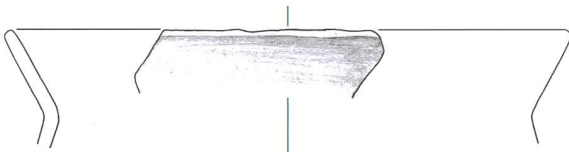

1139

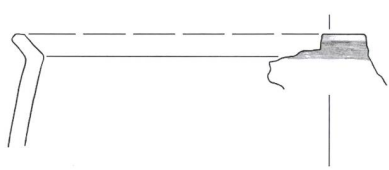

1149

Tafel 85: Cazis, Cresta 1947-1970. Südliche Zentralspalte, Keramikhorizont KH IV. 1135-1149: Planum 14S. Keramik. Mst. 1:3.

1150-1169

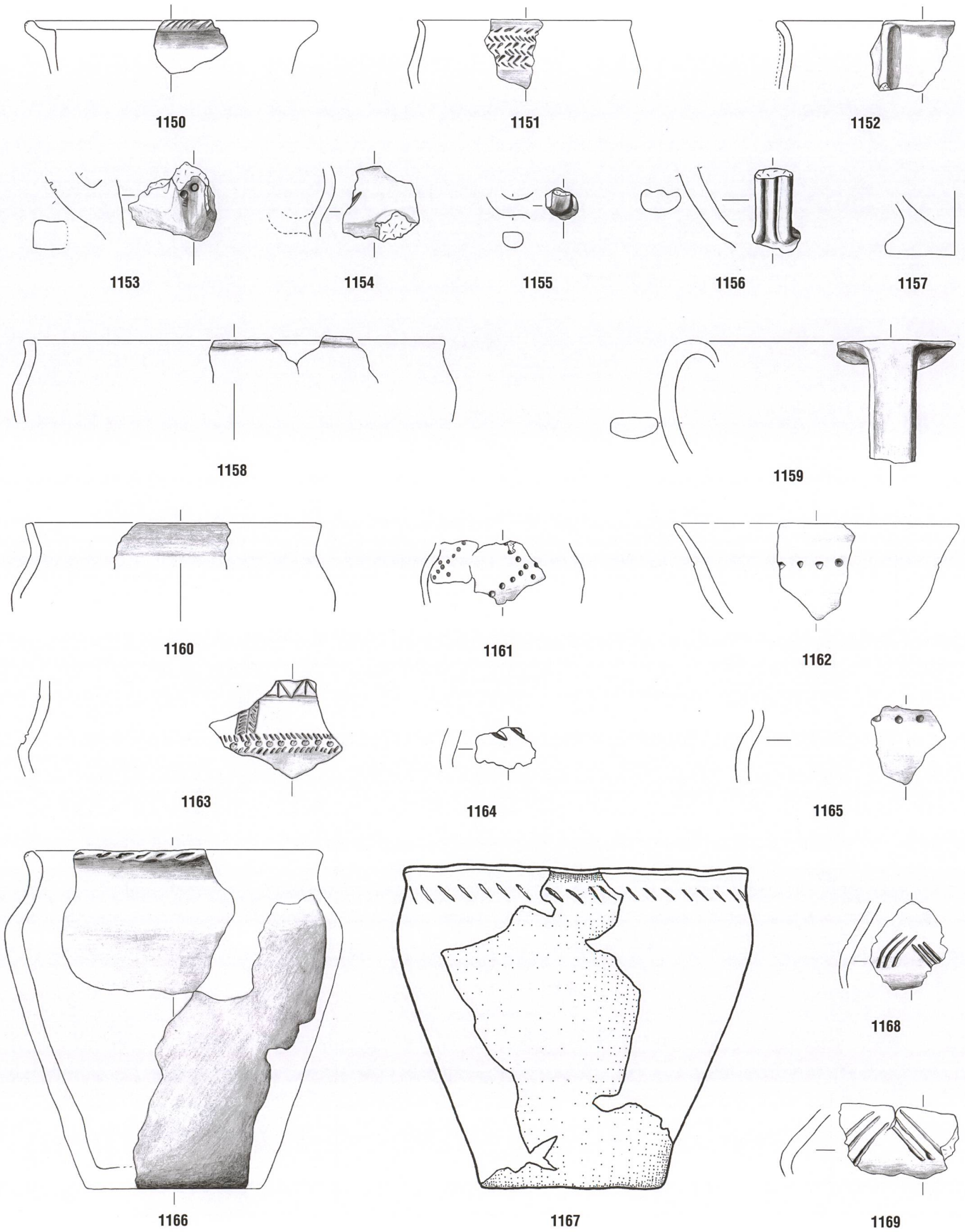

Tafel 86: Cazis, Cresta 1947-1970. Südliche Zentralspalte, Keramikhorizont KH IV. 1150-1169: Planum 14S. Keramik. Mst. 1:3.



1170-1181

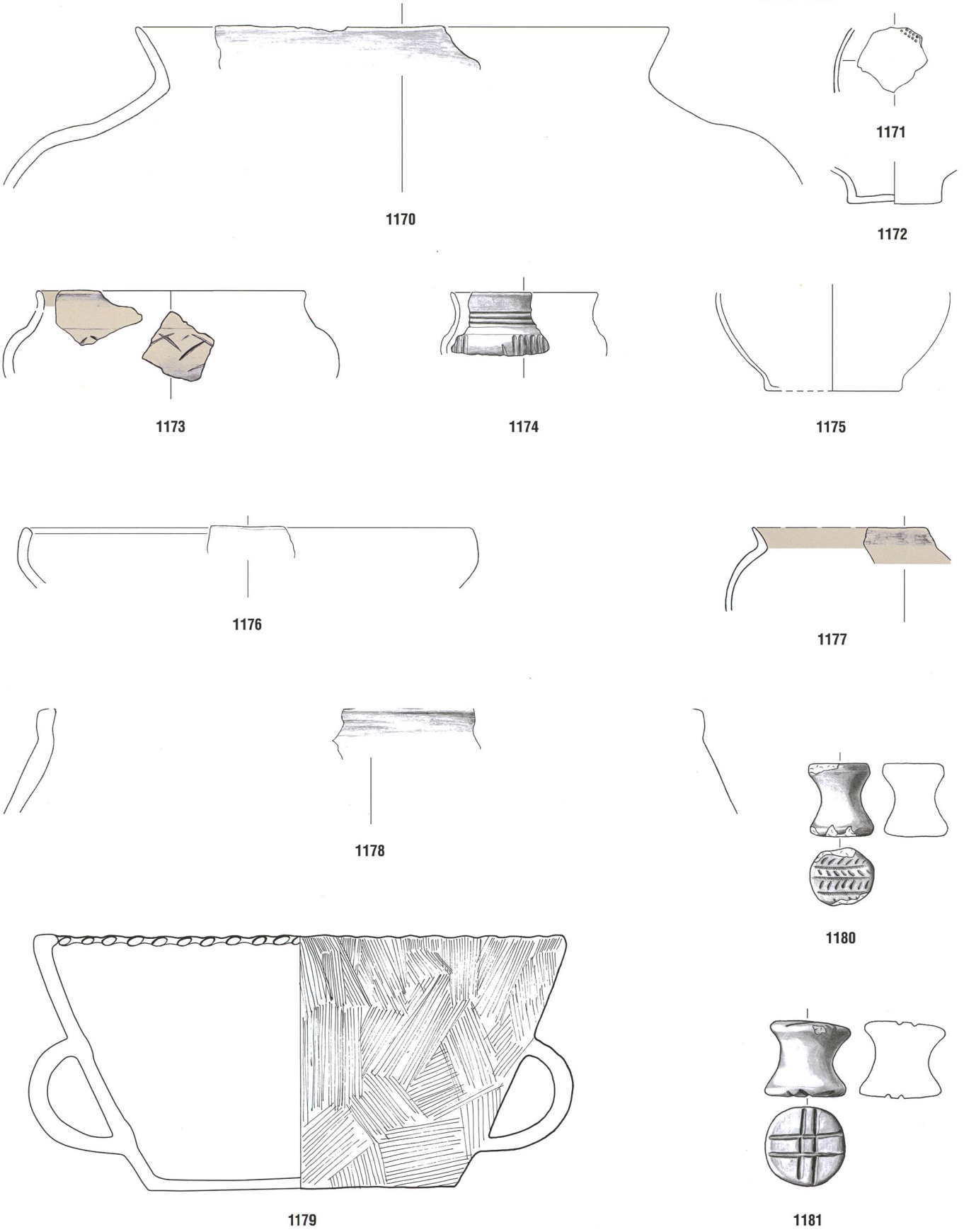

Tafel 87: Cazis, Cresta 1947-1970. Südliche Zentralspalte, Keramikhorizont KH IV. 1170-1181: Planum 14S. Keramik. Mst. 1:3.

1182-1195

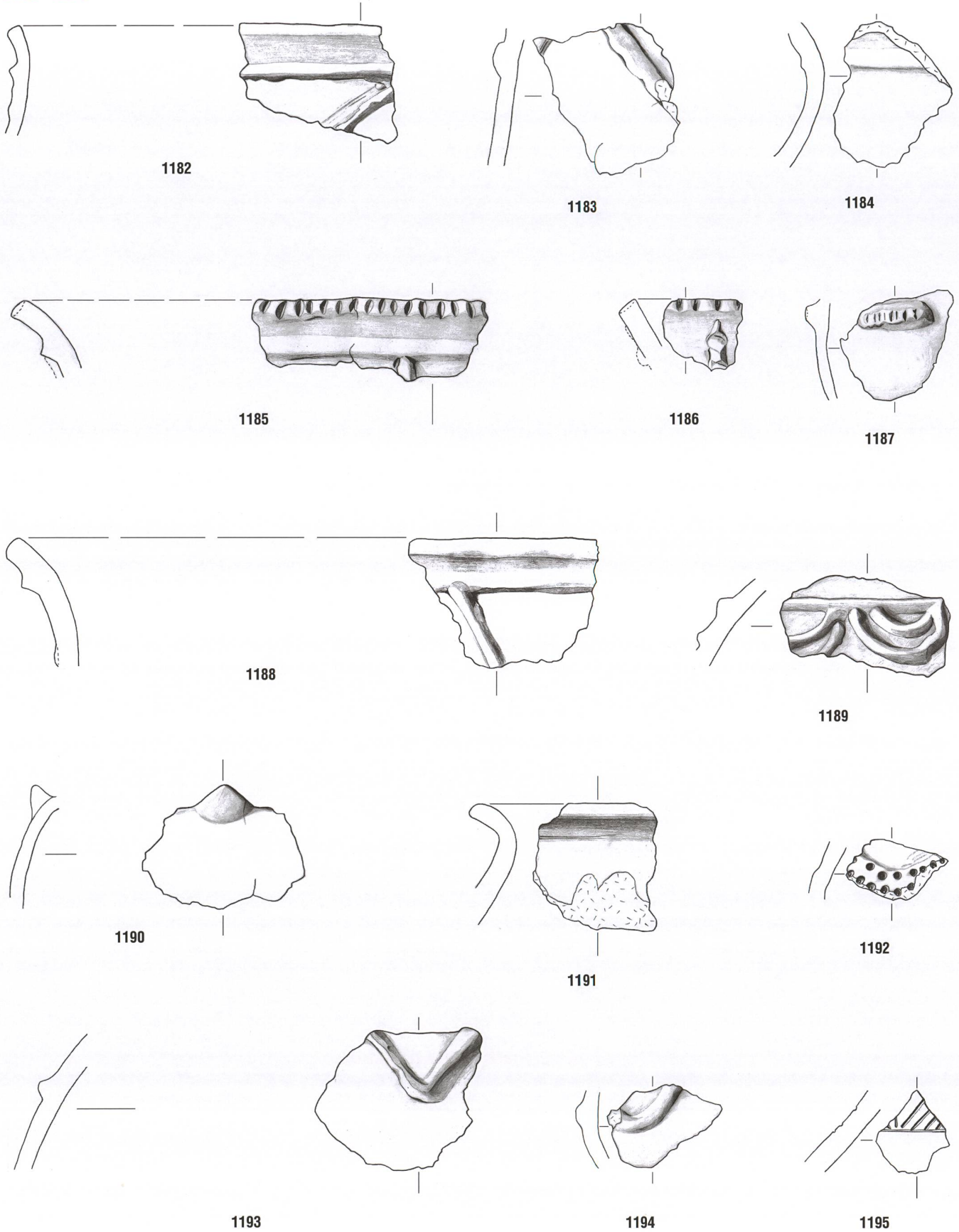

Tafel 88: Cazis, Cresta 1947-1970. 1182-1195: Nordspalte. Keramik. Mst. 1:3.



1196-1209

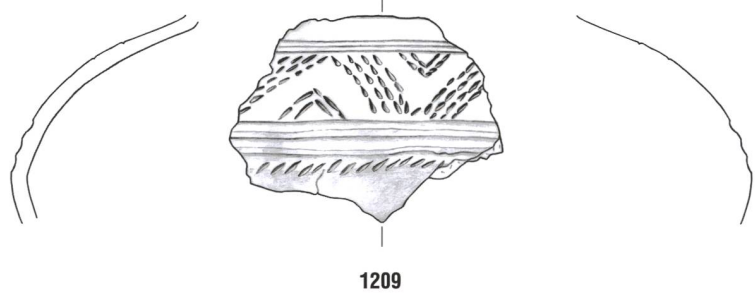
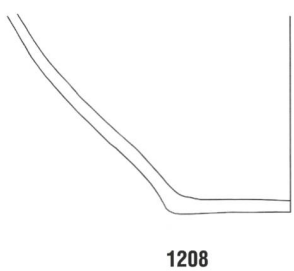
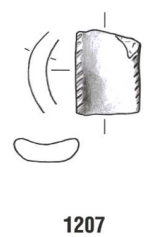
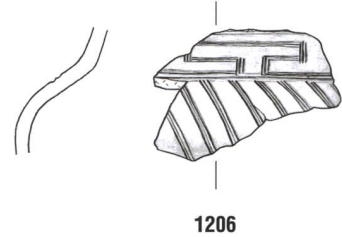
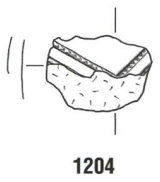
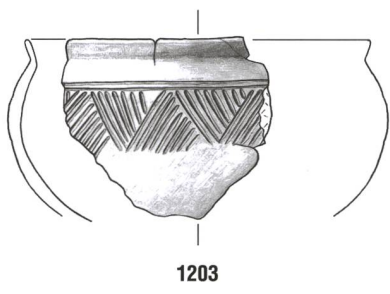
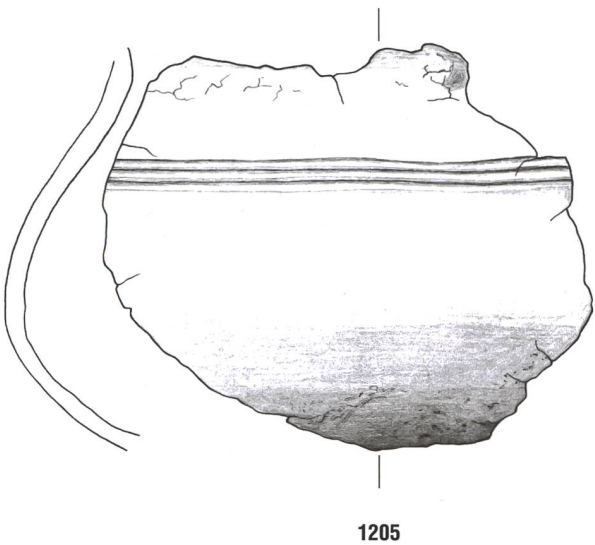
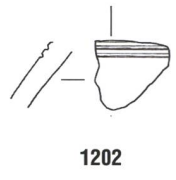
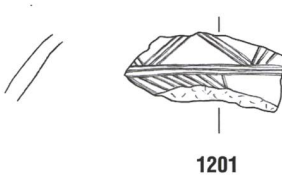
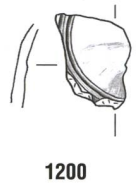
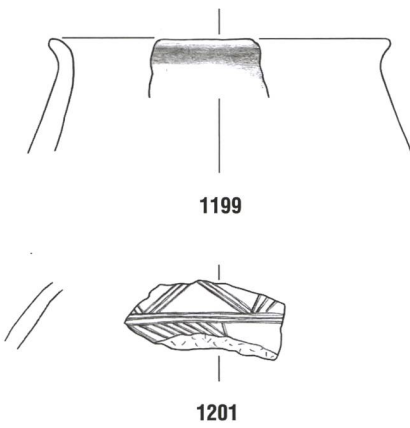
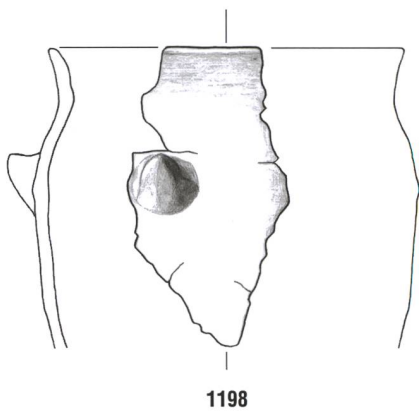
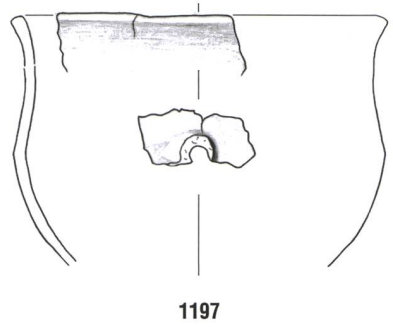
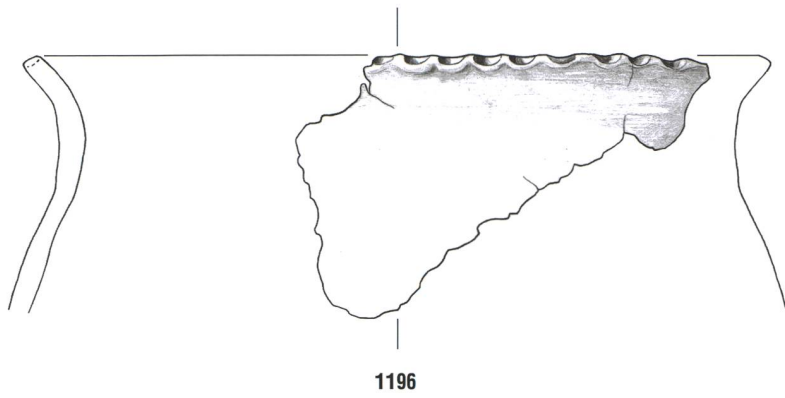

Tafel 89: Cazis, Cresta 1947-1970. 1196-1209: Nordspalte. Keramik. Mst. 1:3.

1210–1224

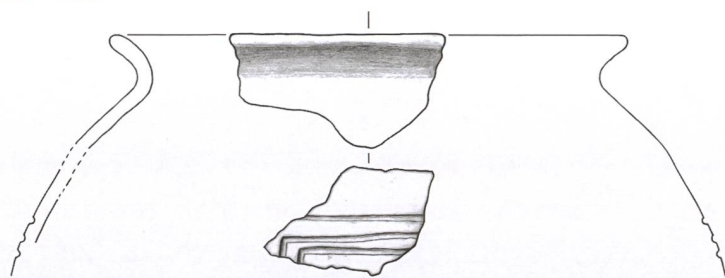

1210

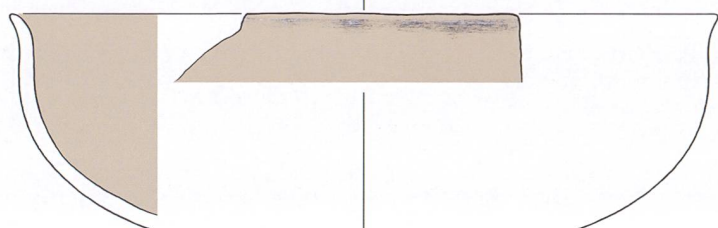

1215

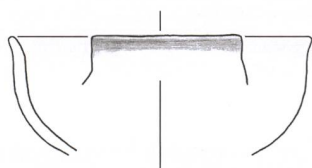

1217

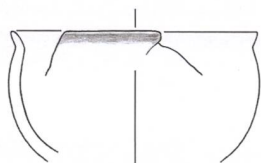

1218

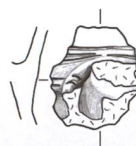

1211

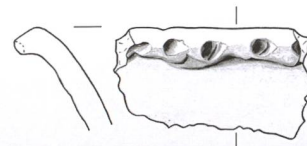

1212

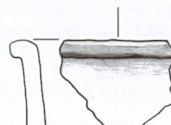

1213



1214

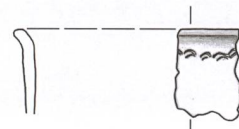

1216



1219

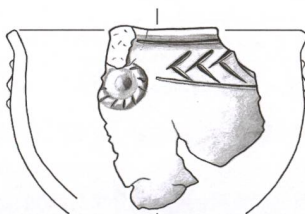

1220

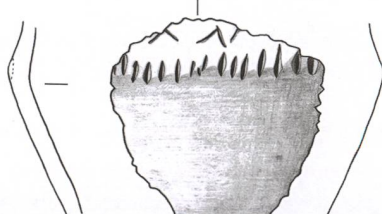

1221

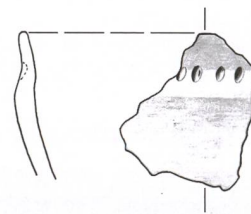

1222

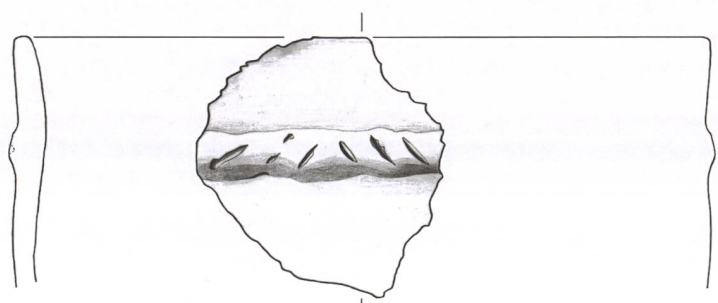

1223

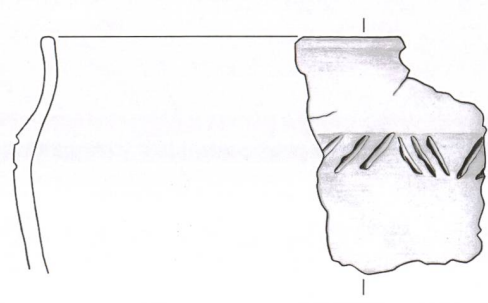

1224

Tafel 90: Cazis, Cresta 1947–1970. 1210–1224: Nordspalte. Keramik. Mst. 1:3.

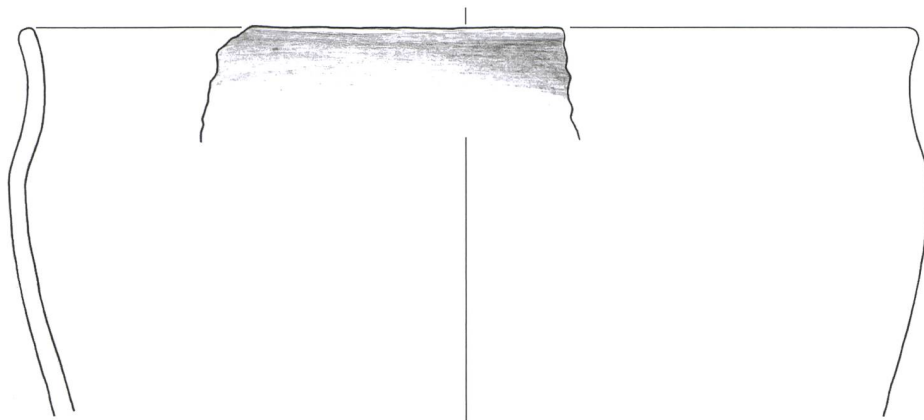

1225

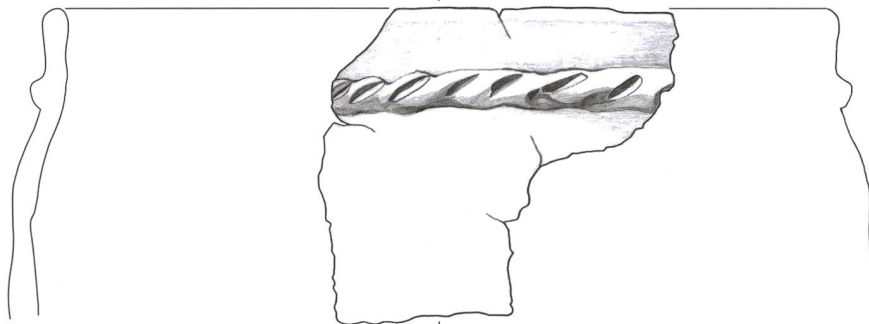

1226

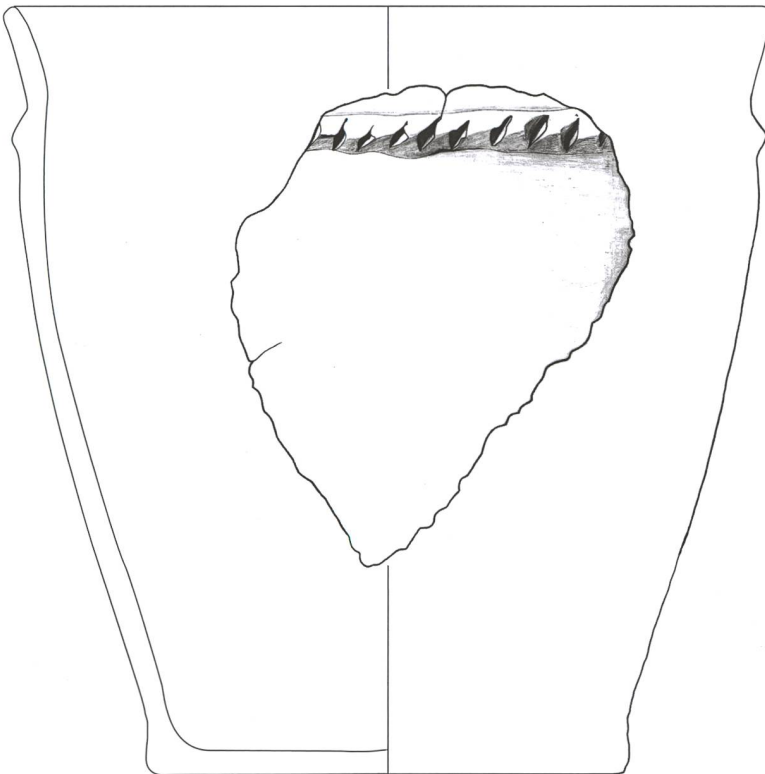

1227

1225–1233

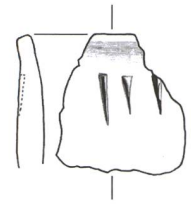

1228

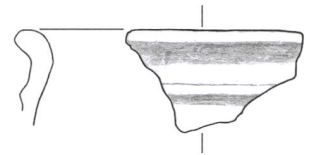

1229

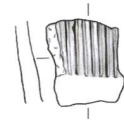

1230

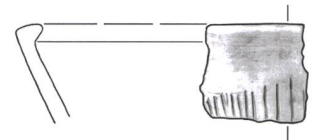

1231



1232

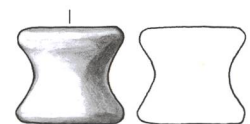

1233

Tafel 91: Cazis, Cresta 1947–1970. 1225–1228: Nordspalte. 1229–1231: Ostfelder. 1232, 1233: Streufunde. Keramik. Mst. 1:3.

1234–1249

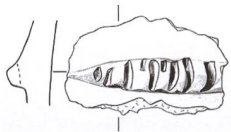

1234

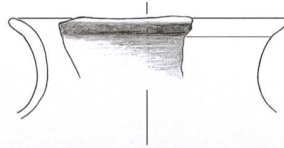

1235

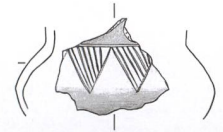

1236

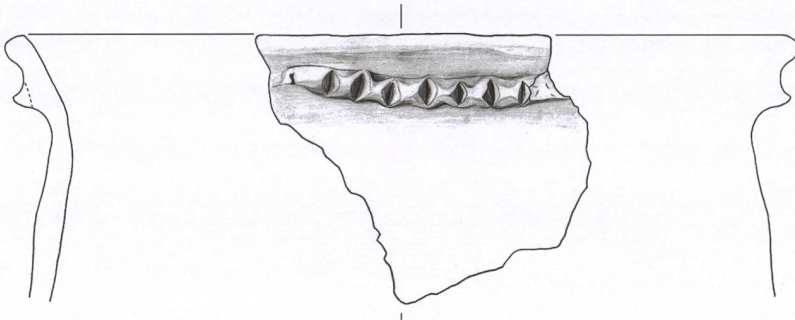

1237

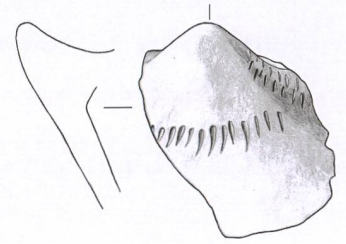

1238

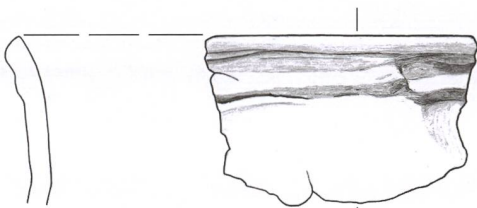

1239



1240

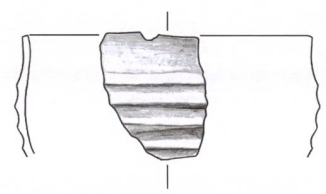

1241

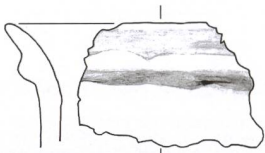

1242

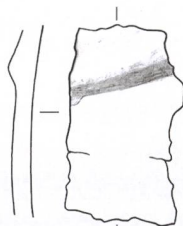

1243

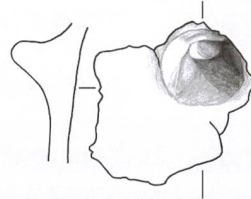

1244

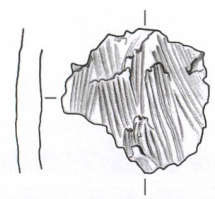

1245

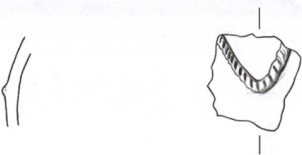

1246

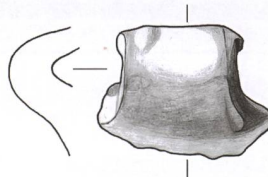

1247

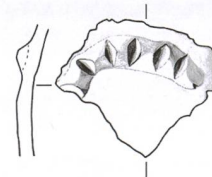

1248



1249

Tafel 92: Cazis, Cresta 1943–1970. 1234–1236: Nördliche Zentralspalte, Streufunde. 1237–1246: Südliche Zentralspalte, Streufunde. 1247–1249: Zentralspalte, Altfunde Feld 1. Keramik. Mst. 1:3.

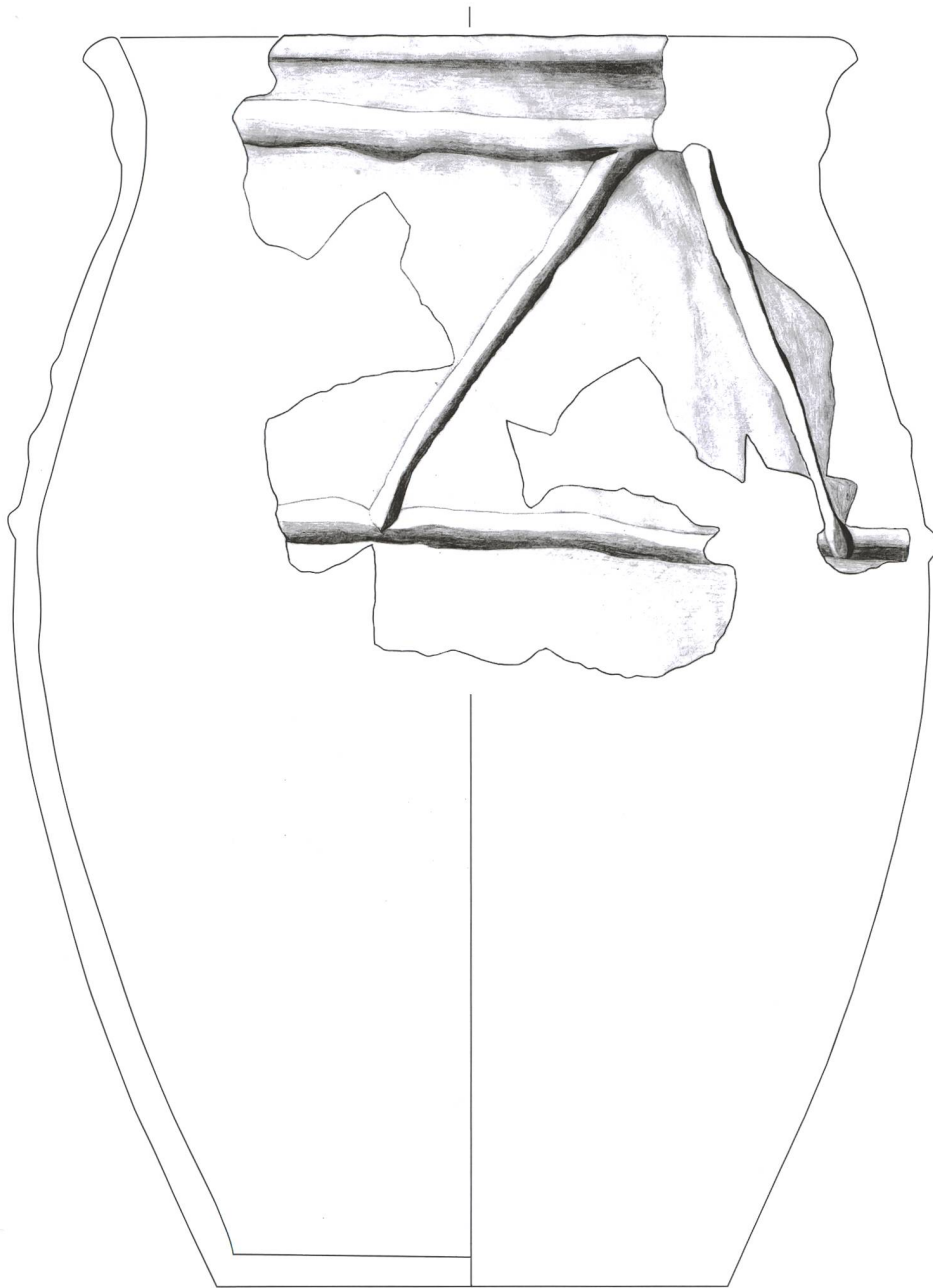

1250

Tafel 93: Cazis, Cresta 1947–1970. 1250: Streufund. Keramik. Mst. 1:3.

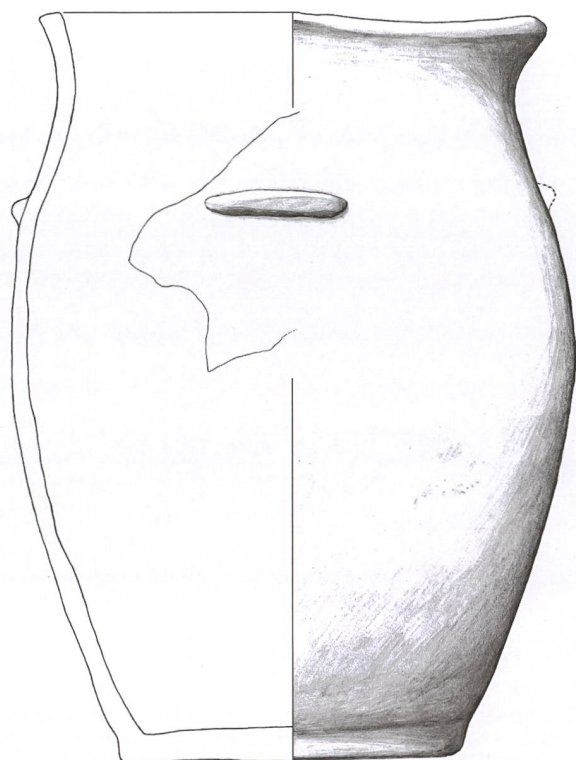

1251

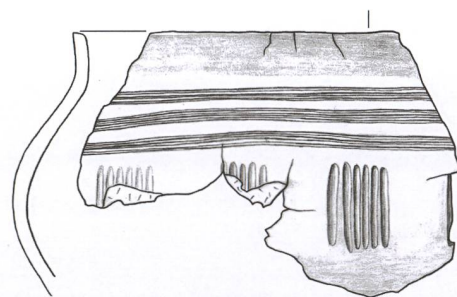

1252

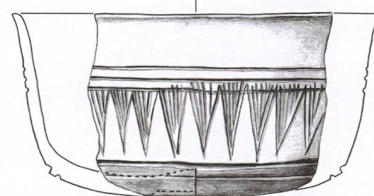

1253



1254



1255

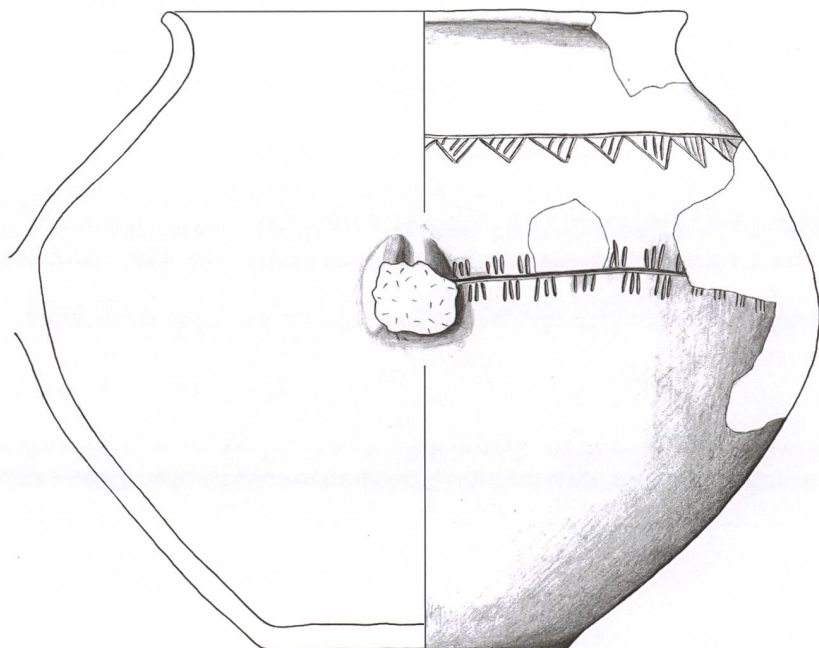

1256

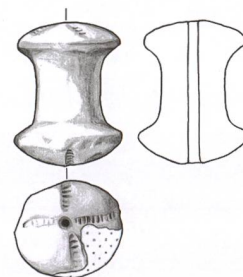

1257

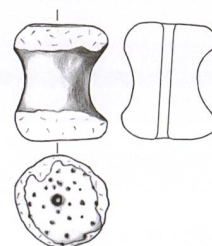

1258

Tafel 94: Cazis, Cresta 1943–1970. 1251, 1256: Südliche Zentralspalte, Streufunde. 1252–1255: Streufunde. 1257–1258: Zentralspalte, Alt-funde Feld 1. Keramik. Mst. 1:3.

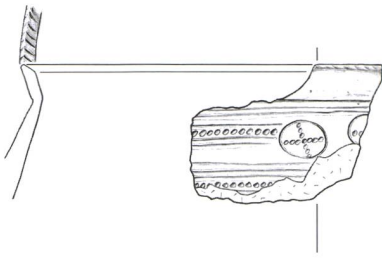

1259

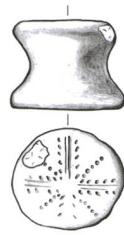

1260

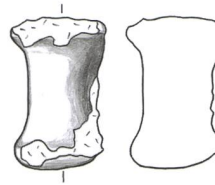

1261

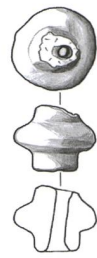

1262

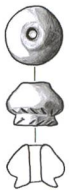

1263

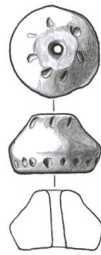

1264

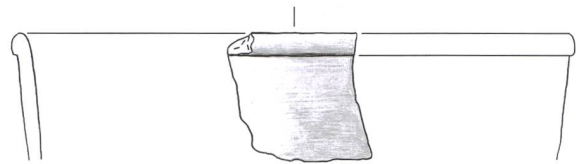

1265



1266

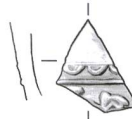

1267

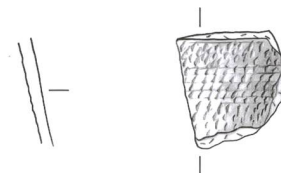

1268

Tafel 95: Cazis, Cresta 1943-1970. 1259-1265: Zentralspalte, Altfunde Feld 1. 1266-1267: Streufunde. 1268: Feld 11, Streufund. Keramik. Mst. 1:3.